

# ***VnmrJ Installation and Administration***

*Varian NMR Spectrometer Systems  
With VnmrJ Software*

*Pub. No. 01-999254-00, Rev. A0604*



**VARIAN**

# ***VnmrJ Installation and Administration***

*Varian NMR Spectrometer Systems  
With VnmrJ Software*

*Pub. No. 01-999254-00, Rev. A0604*



**VARIAN**

*VnmrJ Installation and Administration*  
Varian NMR Spectrometer Systems  
With VnmrJ Software  
Pub. No. 01-999254-00, Rev. A0604

Revision history:  
A0604 – Initial release for VnmrJ 1.1D

Applicability:  
Varian NMR spectrometer systems with workstations running VnmrJ 1.1D software

Technical contributions:  
Technical writer: Everett Schreiber  
Technical editor: Dan Steele

Copyright ©2004 by Varian, Inc., NMR Systems  
3120 Hansen Way, Palo Alto, California 94304  
1-800-356-4437  
<http://www.varianinc.com>  
All rights reserved. Printed in the United States.

The information in this document has been carefully checked and is believed to be entirely reliable. However, no responsibility is assumed for inaccuracies. Statements in this document are not intended to create any warranty, expressed or implied. Specifications and performance characteristics of the software described in this manual may be changed at any time without notice. Varian reserves the right to make changes in any products herein to improve reliability, function, or design. Varian does not assume any liability arising out of the application or use of any product or circuit described herein; neither does it convey any license under its patent rights nor the rights of others. Inclusion in this document does not imply that any particular feature is standard on the instrument.

<sup>UNITY</sup>*INOVA*, *MERCURY*, Gemini, *GEMINI 2000*, *UNITYplus*, UNITY, VXR, XL, VNMR, VnmrJ, VnmrS, VnmrX, VnmrI, VnmrV, VnmrSGI, MAGICAL II, AutoLock, AutoShim, AutoPhase, limNET, ASM, and SMS are registered trademarks or trademarks of Varian, Inc. Sun, Solaris, CDE, Suninstall, Ultra, SPARC, SPARCstation, SunCD, and NFS are registered trademarks or trademarks of Sun Microsystems, Inc. and SPARC International. Oxford is a registered trademark of Oxford Instruments LTD. Ethernet is a registered trademark of Xerox Corporation. VxWORKS and VxWORKS POWERED are registered trademarks of WindRiver Inc. Other product names in this document are registered trademarks or trademarks of their respective holders.

# Overview of Contents

<b>Conventions in This Manual</b> .....	11
<b>Chapter 1. New Workstation Hardware Setup</b> .....	13
<b>Chapter 2. VnmrJ Installation</b> .....	19
<b>Chapter 3. System Configuration</b> .....	29
<b>Chapter 4. Configuring NMR Imaging Systems</b> .....	43
<b>Chapter 5. VnmrJ - Administration</b> .....	45
<b>Chapter 6. VnmrJ-Accounting Administration</b> .....	69
<b>Chapter 7. System Calibration</b> .....	77
<b>Chapter 8. Magnet and Spectrometer Maintenance</b> .....	105
<b>Index</b> .....	139



# Table of Contents

<b>Conventions in This Manual</b> .....	<b>11</b>
<b>Chapter 1. New Workstation Hardware Setup</b> .....	<b>13</b>
1.1 Setting Up Workstation Hardware .....	13
Unpacking the Workstation .....	13
Installing Additional Hardware and Connecting Cables .....	14
1.2 Connecting the Workstation to the NMR Console .....	14
Types of Workstations .....	14
Console and Workstation Connections .....	15
Connecting the Workstation and Console with a Router .....	16
Connecting the Workstation and Console without a Router .....	16
<b>Chapter 2. VnmrJ Installation</b> .....	<b>19</b>
2.1 Operating Systems .....	19
Solaris OS Versions .....	19
Linux® OS Versions .....	19
OS Installation and Administration Manuals .....	19
2.2 Patches .....	20
Preparing for Patch Installation .....	20
2.3 Installing VnmrJ .....	20
2.4 VnmrJ Installation Options .....	23
<b>General Options</b> .....	23
<b>Options Requiring a Password</b> .....	23
2.5 Installing VnmrJ Online Manuals .....	24
Solaris OS .....	24
Linux® OS .....	25
2.6 Error Messages .....	26
Solaris OS .....	26
Linux® OS .....	27
<b>Chapter 3. System Configuration</b> .....	<b>29</b>
3.1 Ethernet Router Installation .....	29
3.2 Setting Up the Host Computer for Data Acquisition .....	29
3.3 Configuring Your System .....	30
About the CONFIG Tool .....	39
3.4 Creating the Acqproc User .....	40
3.5 Setting the Lock Frequency .....	40
3.6 Additional System Configurations .....	40
3.7 Database Hints .....	41
<b>Chapter 4. Configuring NMR Imaging Systems</b> .....	<b>43</b>
4.1 Verifying Imaging Software is Installed .....	43
4.2 Setting the User Interface Type .....	43
4.3 Setting Viewports and Data Saving .....	44

<b>Chapter 5. VnmrJ - Administration</b>	<b>45</b>
5.1 VnmrJ Admin Interface	45
Starting VnmrJ Adm and the VnmrJ Admin Interface	45
VnmrJ Admin Menu Bar	46
Selecting Items	46
5.2 VnmrJ Account Interfaces	47
5.3 Administrating User Accounts	48
VnmrJ Administrator User Account Management Functions:	48
Setting up a New User Account	48
Setting up Multiple New User Accounts	49
Changing the Interface of a User Account	50
Setting Operator Preferences	51
Adding Operators to a User Account	51
Resetting Operator Password	53
Deleting Operators from User Accounts	53
Deleting a User Account	54
Restoring a User Account	55
Converting User Accounts to VnmrJ	55
Updating User Accounts	56
Setting Panel Levels	57
Setting User Templates, Directories, and Defaults	58
5.4 Viewing the Unix File System	60
5.5 Setting Up Investigator List	61
5.6 Setting Up Automation Queue	61
5.7 Managing Printers and Plotters	62
Setting up Printers and Plotters	62
Removing Printers and Plotters	65
Viewing Installed Printers and Plotters	65
5.8 Setting Up DICOM Storage	66
5.9 Setting Background Colors	66
<b>Chapter 6. VnmrJ-Accounting Administration</b>	<b>69</b>
6.1 VNMR Accounting Tool	69
Opening the Accounting Tool	69
Navigating the VNMR Accounting Tool	70
6.2 VNMR Accounting Procedures	71
Setting Up Billing Rates	71
Calculating Billing Information	73
User and Group Information and Lists	74
Generating Reports	74
Managing Groups and Group Members	75
Updating and Saving Records	76
Exiting the Accounting Program	76
<b>Chapter 7. System Calibration</b>	<b>77</b>
7.1 System Calibration Procedure	77
Referenced Manuals	77
Procedure	77
7.2 Calibrating a Probe	78

Logging In and Installing the Probe .....	79
Setting Up the Initial Parameters .....	79
Setting Up the Probe Calibration File .....	79
Tuning Probes .....	80
Starting a Calibration .....	80
Editing Probe Calibration Files .....	81
7.3 AutoCalibration Samples .....	83
7.4 AutoCalibration .....	83
Calibrating Proton .....	83
Calibrating Carbon .....	84
Calibrating Fluorine .....	85
Calibrating Phosphorus .....	85
Calibrating H, C, Ind. Det., and Gradients (CH <sub>3</sub> I) .....	86
Calibrating H, Ind. Det., and Gradients (autotest) .....	87
Calibrating Z0 and Make LOCK gmap .....	87
7.5 Calibrating - Manual Methods .....	88
Calibrating Pulse Width .....	88
Calibrating Decoupler Field Strength .....	89
Calibrating Decoupler 90° Pulse Width with Polarization Transfer .....	90
Calibrating <sup>1</sup> H Decoupler Pulse Width with PPCAL .....	92
Calibrating <sup>13</sup> C (or X) Decoupler Pulse Width with PWXCAL .....	93
7.6 Shimming .....	94
Shim Interactions .....	94
Manual Shimming Using the Lock Level .....	100
Gradient Shimming .....	103
<b>Chapter 8. Magnet and Spectrometer Maintenance .....</b>	<b>105</b>
8.1 Preventative Maintenance .....	105
Scheduled Maintenance .....	105
Maintenance Documentation .....	106
8.2 Handling Liquid Helium .....	106
Physical Properties of Helium .....	106
Handling Liquid Helium Safely .....	108
Measuring Liquid Helium .....	109
Transferring Liquid Helium .....	109
8.3 Continuing Dewar Service .....	111
Liquid Helium Service .....	111
Helium Refilling on Oxford 200- and 300-MHz Magnets .....	114
Determining Stinger Lengths for Storage Containers .....	115
8.4 Troubleshooting .....	116
Sample Scoring Problems .....	116
Sample Changer Troubleshooting .....	116
Other Troubleshooting Solutions .....	117
Shim Gradient Supply Data Connection on <sup>UNITY</sup> INOVA .....	121
C.1 Configuring Printer and Plotter Hardware .....	123
Hewlett-Packard LaserJet 840C Printer .....	123
Lexmark Optra Color 45 Inkjet Printer .....	124
Hewlett-Packard DeskJet 5550 Printer .....	126
Hewlett-Packard DeskJet 970Cxi Printer .....	127



Table of Contents

Hewlett-Packard LaserJet 2300 Printer .....	127
Hewlett-Packard LaserJet 2100 Printer .....	128
Hewlett-Packard Color LaserJet 4550 Printer .....	128
Hewlett-Packard LaserJet 5000 Series Printers .....	129
Hewlett-Packard Color Inkjet CP1700 Printer .....	130
Overview .....	130
<b>C.2</b> Printer Troubleshooting and Hints .....	130
Solaris Related .....	131
Generic Solutions .....	133
Linux Related .....	134
<b>E.1</b> File Browser .....	137
Instructions .....	137
<b>E.2</b> Image Browser .....	138
<b>Index</b> .....	<b>139</b>

# List of Figures

Figure 1. Workstation to Console Connections .....	15
Figure 2. <i>MERCURYplus</i> /-Vx Ethernet Connections .....	16
Figure 3. <sup>UNITY</sup> <i>INOVA</i> Universal Ethernet Connections .....	17
Figure 4. Installation Windows.....	21
Figure 5. Progress Window .....	22
Figure 6. System Settings Windows .....	31
Figure 7. Configuration Tool .....	32
Figure 8. VnmrJ Admin Window .....	44
Figure 9. VnmrJ Administrator Window .....	45
Figure 10. VNMR Accounting Window.....	69
Figure 11. Add Accounting Group Window.....	71
Figure 12. Add Group Window, Single Rate.....	71
Figure 13. Add Group Window, Multi Rate .....	72
Figure 14. Assign Holidays Window.....	73
Figure 15. Console Users Window for a Selected User .....	74
Figure 16. Console Log Window.....	74
Figure 17. Printer Selection Window .....	75
Figure 18. Add User Window.....	75
Figure 19. Console Users Window .....	75
Figure 20. Calibrating a Probe.....	79
Figure 21. Measuring Residual Couplings in Dioxane.....	90
Figure 22. PPCAL Pulse Sequence .....	92
Figure 23. Approximate Shape of Axial Gradients .....	94
Figure 24. Theoretically Perfect Lineshape.....	95
Figure 25. Effects of Linear Shim Z1 .....	95
Figure 26. Effects of Even Order (Parabolic) Shims Z2 and Z4 .....	96
Figure 27. Effect of Odd Order (Non-Linear) Shims Z3 and Z5.....	97
Figure 28. Effects of Misadjusted Shims.....	98
Figure 29. Effects of Nonspin Shims.....	99
Figure 30. Precooling the Liquid Helium Transfer Tube .....	112
Figure 31. Routine Filling of the Magnet Dewar .....	113
Figure 32. Stinger Configuration Measurements on the Storage Container.....	115

## List of Tables

Table 1. Connecting 10baseT and 10/100baseT Ethernet Boards .....	15
Table 2. General Configuration .....	34
Table 3. RF Channels Configuration .....	36
Table 4. Gradient Configuration .....	37
Table 5. <i>MERCURYplus/-Vx</i> Configuration .....	38
Table 6. VNMR Printer and Plotter Types with Descriptions .....	63
Table 7. AutoCalibration Samples .....	83
Table 8. Lineshape Effects and Their Associated Shims .....	100
Table 9. Physical Properties of Helium and Nitrogen .....	107
Table 10. VxWorks Prompts, Values, and Descriptions .....	119
Table 11. LaserJet Plot Resolution .....	132
Table 12. LaserJet Plot Resolution .....	134

## Conventions in This Manual

The following notational conventions are used throughout VNMR manuals:

- Typewriter-like characters identify VNMR and UNIX commands, parameters, directories, and file names in the text of the manual:  
The `shutdown` command is in the `/etc` directory.
- Typewriter-like characters also show text displayed on the screen, including the text echoed on the screen as you enter commands:  
`Self Test Completed Successfully.`
- User input is usually shown in bold type:  
# **cd /cdrom**  
# **ls**  
`cdrom0      solaris_2_5_1_desktop_1_1`  
#
- Input or output that depends on local use is shown in italics:  
Login: **root**  
Password: *root\_password*
- Optional input is shown by angled brackets:  
`seqgen s2pul<.c>` means that `seqgen s2pul.c` and `seqgen s2pul` are functionally the same.
- Lines of text containing command syntax, examples of statements, source code, and similar material are often too long to fit the width of the page. To show that a line of text had to be broken to fit into the manual, the line is cut at a convenient point (such as at a comma near the right edge of the column), a backslash (`\`) is inserted at the cut, and the line is continued as the next line of text. This notation is familiar to C programmers. Note that the backslash is not part of the line and, except for C source code, should not be typed when entering the line.
- Because pressing the Return key is required at the end of almost every command or line of text you type on the keyboard, use of the Return key is usually mentioned only in cases where it is *not* used. This convention avoids repeating the instruction “press the Return key” throughout most of this manual.



## Chapter 1. New Workstation Hardware Setup

Sections in this chapter:

- 1.1, “Setting Up Workstation Hardware,” this page
- 1.2, “Connecting the Workstation to the NMR Console,” on page 14

This chapter describes how to set up a workstation and how to connect it to a Varian Inc., NMR spectrometer.

After the hardware is setup, you will most likely have to install the workstation operating system. Refer to the manual *Solaris Administration* manual for more information on installing Solaris. Refer to the Linux documentation for installing Linux.

### 1.1 Setting Up Workstation Hardware

Setting up the workstation hardware involves the following steps:

- “Unpacking the Workstation,” next
- “Installing Additional Hardware and Connecting Cables” on page 14

#### Unpacking the Workstation

The first step in setting up the computer is removing it from the packaging. Go over the documentation that came with the workstation. If your workstation is already unpacked, go to the next section.

**CAUTION:** Keep the computer and the monitor away from the magnet. Magnetic fields can damage the computer hard drive and there are metal parts inside a monitor. Make sure staples in the box do not get into the magnet.

1. Inspect all shipping cartons *immediately* for evidence of damage.
  - If any shipping carton is damaged, request that the carrier’s agent be present when the carton is opened.
  - If the agent is not present and the contents are found to be damaged, keep all contents and packing material for agent’s inspection.
2. Unpack the computer carefully (instructions might be printed on the outside of the shipping container).
  - Place the computer on a sturdy table or desk where you can easily work on the unit.
  - Place the other components separately on a sturdy table or desk, but do not connect any of the units yet.

## Installing Additional Hardware and Connecting Cables

This section describes how to set up the computer hardware after it is unpacked.

1. If you purchased any add-on boards with your system (including a second Ethernet or SCSI board), install them in the workstation now according to the instructions that came with the accessory.
2. If you purchased any optional internal devices, such as a floppy disk drive or an internal CD-ROM drive, install them now according to the instructions that came with the unit.
3. Place the computer and monitor in the final location.
4. Connect the keyboard, monitor, and mouse.

## 1.2 Connecting the Workstation to the NMR Console

This section describes how to connect the Workstation host computer to the NMR console.

UNITY*INOVA* and *MERCURYplus/-Vx* spectrometers connect to the host computer through an Ethernet interface.

- “Types of Workstations,” next
- “Console and Workstation Connections” on page 15
- “Connecting the Workstation and Console with a Router” on page 16
- “Connecting the Workstation and Console without a Router” on page 16

### Types of Workstations

- “Sun Workstations,” next
- “Linux Workstation” on page 15

The workstation can contain one or two Ethernet boards. Labeling of the Ethernet boards depends upon the type of workstation:

#### *Sun Workstations*

If the workstation has two Ethernet boards, the built-in Ethernet is called the *first Ethernet*; this is labeled TP <...> on the back of the Sun computer and the port is referred to by UNIX as `ce0`, `eri0`, `hme0`, or `le0`. The *second Ethernet* is the one added as a PCI or S-bus board, and the port is referred to by UNIX as `hme1` or `le1`. On Sun Blade computers, the second port is referred to by UNIX as `hme0` or `le0`.

If the spectrometer is to be connected to an Ethernet network, the host computer must have two Ethernet boards, one for the NMR console and one for the main Ethernet network. Either one of the Ethernet boards can be 10baseT (`le`) or autosensing 10/100baseT (`eri0` or `hme0`). Always select the fastest port (`eri` and `hme` are faster than `le`) for the main Ethernet network and connect the slower port to the NMR console. [Table 1](#) lists the Ethernet board combinations and how to connect them to the NMR console and main network.

**Table 1.** Connecting 10baseT and 10/100baseT Ethernet Boards

Sun Computer Ethernet Boards		Ethernet Ports to Use	
First	Second	Main Network	NMR Console
10/100/1000	10/100	ce0	eri0
10/100/1000	10/100	ce0	line0
10/100	10/100	eri0	hme0
10/100	10/100	hme0	hme1
10/100	10	hme0	le0
10	10	le0	le1

### Linux Workstation

Refer to the documentation provided with the Linux workstation for identification of the Ethernet boards. Some systems have built in Ethernet port and an Ethernet board while other have two Ethernet boards. Typically both ports are the autosensing 10/100base type.

Refer to the documentation provided with the Linux software for specifying the ports.

### Console and Workstation Connections

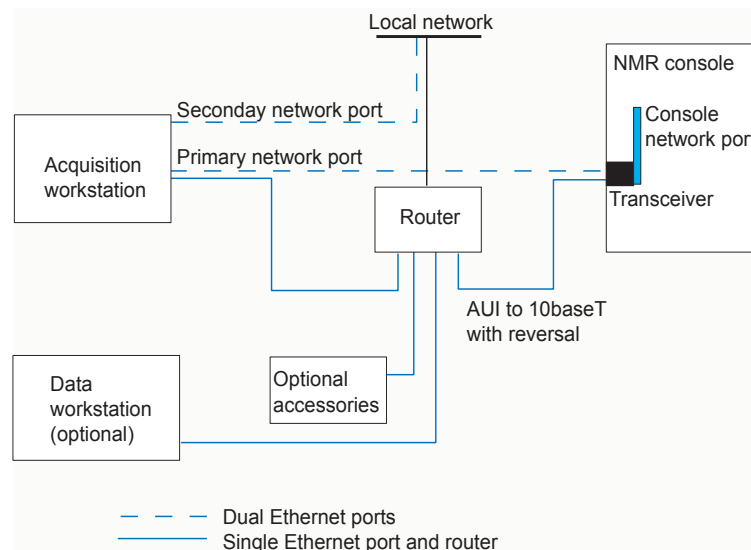
**Figure 1.** Workstation to Console Connections

The workstation and console can be connected by either of the following:

- A single Ethernet port and router are used to establish a line between the workstation, NMR console, any network compatible accessories, and the main network on-site.
- Two Ethernet ports are installed in the workstation. The typical Sun workstation has a standard on-board Ethernet port that is referred to as the primary port. The primary port connects to the NMR console. The second port connects the workstation to the main network on-site.



## Connecting the Workstation and Console with a Router

Follow the directions supplied in the *Network Interface Installation* manual.

## Connecting the Workstation and Console without a Router

- “To Connect MERCURYplus/-Vx to the Host,” next
- “To Connect the <sup>UNITY</sup>INOVA to the Host” on page 16

### To Connect MERCURYplus/-Vx to the Host

The host computer can be connected to *MERCURYplus/-Vx* NMR consoles at any time, before, during, or after the software installation. The host and the console must both be connected and powered up, however, before the `setacq` command is executed.

The Ethernet cable is a shielded 10baseT reversal cable, identified by blue sleeves at both ends.

1. Connect the AUI-to-10baseT transceiver to the NMR console as (see [Figure 2](#)) follows:  
Connect to the ETHERNET PORT on the Acquisition CPU board, which is the first board on the left in the digital card cage.
2. Connect one end of the 10/100baseT cable to the transceiver.
3. Connect the other end of the 10/100baseT cable to the slower of the two Ethernet ports on the back of the Sun computer. Refer to [Table 1](#).

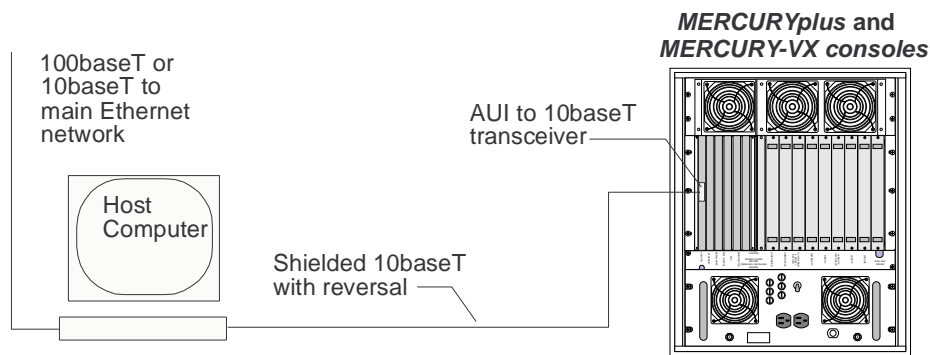

**Figure 2.** *MERCURYplus/-Vx* Ethernet Connections

### To Connect the <sup>UNITY</sup>INOVA to the Host

The Ethernet cable is a shielded 10/100baseT reversal cable, identified by blue sleeves at both ends. The Motorola 162 CPU needs a transceiver; the Power PC does not.

1. Connect the AUI-to-10baseT transceiver to the Ethernet connector on the Acquisition CPU board, illustrated in [Figure 3](#).  
The Acquisition CPU board is the left most board in the digital card cage, facing the front.
2. Connect one end of the 10/100baseT cable to the transceiver and route it through the opening in the left of the digital card cage and through the hole in the back of the console.

3. Connect the other end of the 10baseT cable to the slower of the two Ethernet ports on the back of the Sun computer. Refer to [Table 1](#).

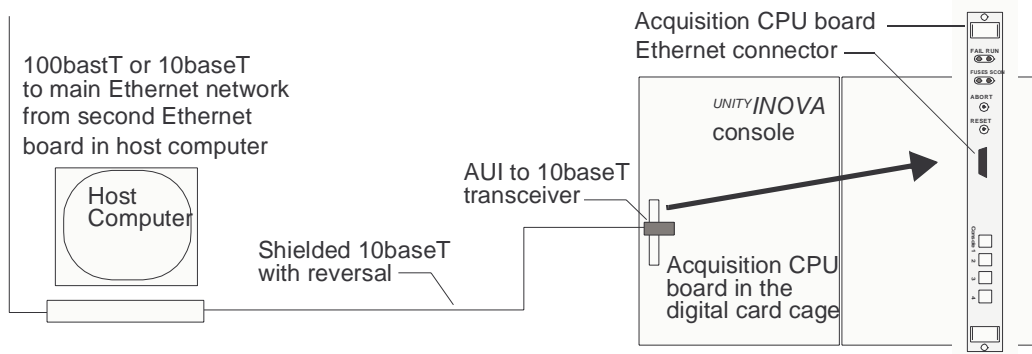

**Figure 3.** UNITY INOVA Universal Ethernet Connections



## Chapter 2. VnmrJ Installation

Sections in this chapter:

- [2.1 “Operating Systems,” this page](#)
- [2.2 “Patches,” page 20](#)
- [2.3 “Installing VnmrJ,” page 20](#)
- [2.4 “VnmrJ Installation Options,” page 23](#)
- [2.5 “Installing VnmrJ Online Manuals,” page 24](#)
- [2.6 “Error Messages,” page 26](#)

This chapter describes how to install operating system (OS) patches and the VnmrJ software and online help.

Before installing VnmrJ, the hardware Operating Systems (OS) and all patches must be installed.

### 2.1 Operating Systems

VnmrJ 1.1D and newer is supported with the following Operating Systems (OS). Refer to the documentation supplied with the hardware to determine the OS and version supported by that hardware.

- [“Solaris OS Versions,” next](#)
- [“Linux® OS Versions,” next](#)
- [“OS Installation and Administration Manuals,” next](#)

#### Solaris OS Versions

- Solaris 7
- Solaris 8
- Solaris 9

#### Linux® OS Versions

- Redhat Linux® version 9 or newer

#### OS Installation and Administration Manuals

- *Solaris Installation and Administration* (Pub. No. 01-999270-00)
- *Linux® Installation* (Pub. No. 01-999268-00)

## 2.2 Patches

VnmrJ is installed from multiple VnmrJ CD-ROMs and a CD-ROM containing required patches for the OS:

- *VnmrJ Operating System Patches* — patches for the workstation OS.
- *VnmrJ*
- *VnmrJ – Manuals and VnmrJHelp*

Before installing VnmrJ, install any operating system patches that are necessary for proper VnmrJ and VNMR operation. Patches are provided on the CD-ROM included with the software or visit the Varian NMR User Page at <http://www.varianinc.com>. Click on **NMR** in the list of *Scientific Instruments*, then click on **User Page** in the *Quick Links* section.

### Preparing for Patch Installation

Before you begin installing patches, make sure the following conditions are true:

- VnmrJ is not running.
- No users are logged on to your system (use the `who` command to verify this condition).
- The NMR console is idle.
- Refer to the appropriate OS administration manual:
  - Solaris Operating System — *Solaris Installation and Administration* manual
  - Linux Operating System — *Linux® Installation* manual

After you have installed operating system patches, proceed to the next section, [2.3 “Installing VnmrJ,” page 20](#).

## 2.3 Installing VnmrJ

**CAUTION:** You must exit all running programs of VnmrJ and VNMR and stop the `proc_family` from running. Use the command `su acqproc`. The installation of VnmrJ automatically creates a link of `/vnmr` to the VnmrJ home directory.

1. Exit all instances of *VnmrJ* and VNMR.
2. Stop all `proc_family` processes - use `su acqproc`.  
Refer to [“Creating the Acqproc User,” page 40](#) for instructions on creating the `acqproc` user if this user does not exist.
3. Stop if the latest OS patches are not installed or continue with [step 4](#) if all OS patches are installed.  
If you have not installed the patches, follow the instructions in section [2.2 “Patches,” page 20](#) before proceeding with VnmrJ installation.
4. Log in as `root` or use the `su` command to become root.  
*Do not switch user to root using `su -`.*
5. Open a terminal window.
6. Follow the instruction appropriate for the installed operating system:

- **Solaris with CDE running**
    - a. Insert the *VnmrJ* CD-ROM in the CD-ROM drive.
    - b. Enter `cd /cdrom/cdrom0` in a terminal console.
  - **Linux**
    - a. Insert the *VnmrJ* CD-ROM in the CD-ROM drive.
    - b. Enter `cd /mnt/cdrom` in a terminal console.
7. Enter `./load.nmr` command in a terminal console window to open the installation window and start the installation (Figure 4).
  8. If you are not `root` yet, the system asks you for the root password.
  9. At the top of the window, select INOVA or MERCURY.
  10. Then select the appropriate options for your system.
 

Section 2.4 “VnmrJ Installation Options,” page 23 lists and describes the available options. Options can be installed at any time after VnmrJ is installed by inserting the CD-ROM and repeating the installation procedure selecting (checking the box) only the options to be installed – all other boxes are unchecked.
  11. If desired, enter a new path for the **VnmrJ home directory**. As an example, replace `VnmrJ_1.1D` with an appropriate name.

**CAUTION:** Avoid overwriting the current version of VnmrJ. Make sure that the path in the *VnmrJ home directory* entry is different from previous versions of VnmrJ; otherwise, the installed version of VnmrJ will be overwritten.

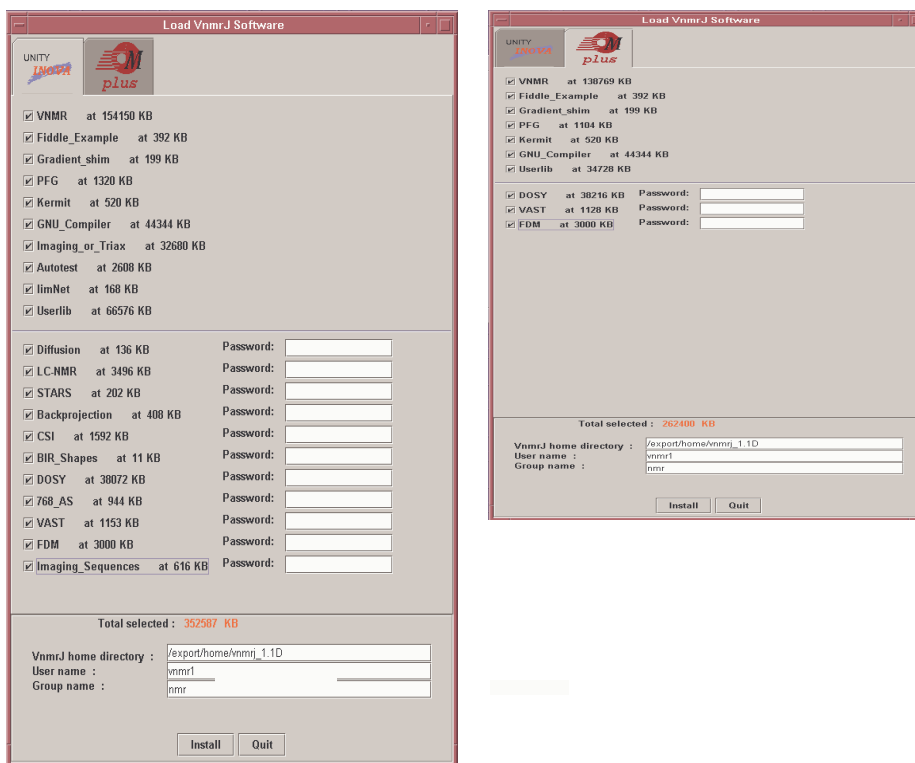
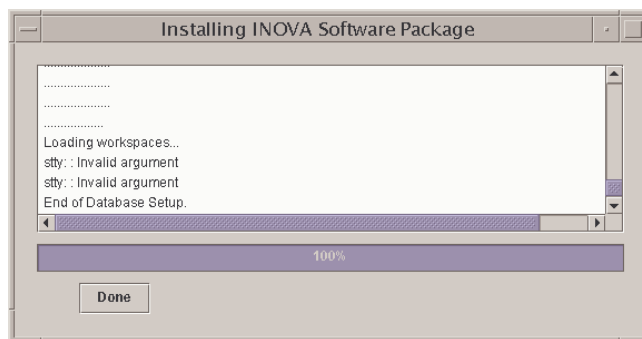

Figure 4. Installation Windows

12. Enter the VnmrJ administrator for the **User name**.  
If the directory and user account for the VnmrJ owner exists, the installation program uses them. If not, they are created for you.
13. Enter the OS group name of the *VnmrJ* administrator **Group name** if it is not correct.
14. Click the **Install** button.  
Installation might take several minutes, depending on the number of options selected. During the installation a pop up window displays the progress. A beep sounds when it finishes, and the **Cancel** button in the progress window (Figure 5) changes to **Done**. Click the **Done** button and the following messages appear:



**Figure 5.** Progress Window

If your system is a spectrometer:

1. Exit all Vnmr/VnmrJ programs.
2. Run `/vnmr/bin/setacq`

On all systems:

1. Run `/vnmr/bin/makeuser` for every user  
You can also use `vnmrj adm` for this  
See Configure->Users->Update users . . .
2. In the VnmrJ interface from Utilities->System settings . . .  
click System config

**Note:** After software installation has been completed and if you had a previous version of VnmrJ or VNMR installed, the `/vnmr/conpar` file, the `/vnmr/devicenames` file, and the following directories are copied to the new `/vnmr` directory:

- shims
- probes
- imaging/decclib
- imaging/gradtables
- fastmap
- adm/users
- asm/info
- dicom/config

## 2.4 VnmrJ Installation Options

The installation program enables you to select from a list of *general* and *password* options to be installed with VnmrJ.

- “General Options,” next
- “Options Requiring a Password,” next

### General Options

The following is a list of general options and descriptions. Click the box next to each option you want to load. A check mark appears to show that the option is selected.

<i>Option</i>	<i>Description</i>
VNMR	Loads the basic VnmrJ and VNMR packages.
Fiddle_Example	Loads example of fiddle reference deconvolution.
Gradient_shim	Loads software for gradient shimming.
PFG	Loads <code>seqlib</code> , <code>psglib</code> parameters and other files for PFG experiments.
Kermit	Loads the Kermit (serial port) communication software. This is shareware. Needed for field mapping.
GNU_Compiler	Loads the GNU C compiler. This is shareware needed for pulse sequence programming.
Imaging_or_Triax	Loads software for imaging or triple axis gradient.
AutoTest	Loads AutoTest software for automated system testing.
limNet	Loads the Limnet software. Needed for ethernet communication between SUN and VXR or Gemini systems that run PASCAL OS.
Userlib	Loads Userlib.

### Options Requiring a Password

The following is a list of options (and descriptions) that require a password . When selected a password field will become visible. Enter your password in the field (passwords are case-sensitive)

<i>Option</i>	<i>Description</i>
Diffusion	Software for running diffusion experiments.
LC-NMR	Software for driving LC-NMR experiments.
STARS	A software simulation package.
Backprojection	Loads the back projection programs.
CSI	Loads files for Chemical Shift Imaging.
BIR_shapes	Loads BIR-shaped pulse statements which provide variable tip-angle adiabatic pulses.
DOSY	Loads DOSY experiment to separate resonances based on differing diffusion characteristics.
768_AS	Loads software for 768 AS sample changer accessory.
VAST	Loads software for VAST sample changing accessory.
FDM	Loads software for FDM data processing methods.
Imaging_Sequences	Loads special pulse sequences for imaging.



## 2.5 Installing VnmrJ Online Manuals

VnmrJ manuals can be installed onto your system or read them directly from the *VnmrJ Online Manuals* CD-ROM (which must be then left in the CD-ROM drive). You can install either individual manuals or the entire manual set. The appropriate manuals are loaded based on the `/vnmr/vnmrrev` file.

You can view online manuals with Acrobat Reader. When you install the Online Manuals and CD-ROM, all manuals are copied to the hard drive along with a copy of the Acrobat Reader.

The CD-ROM also contains VnmrJ Help, which is available from the Help menu.

- “Solaris OS,” next
- “Linux® OS,” page 25

### Solaris OS

These instructions apply to Sun workstations running the Solaris Operating System.

- “Loading Online Manuals from a Terminal Console Window,” next
- “Loading Online Manuals from the CDE File Manager,” next
- “Ejecting the CD-ROM,” next

#### *Loading Online Manuals from a Terminal Console Window*

To load *VnmrJ 1.1C–Online Manuals* this way, do the following steps:

1. Log in as `root` or use the `su` command to become `root`.  
*Do not switch user to root using `su -`.*
2. With CDE running, insert the *VnmrJ Online Manuals* CD-ROM in the CD-ROM drive. If you are not `root` yet, the system asks you for the root password.  
A CDE **File Manager – vnmrj\_online** window appears.
3. Open a terminal console window.
4. Change to the `vnmrj_online` directory on the CD-ROM:  
Enter `cd /cdrom/cdrom0`
5. Look at the contents in the `vnmrj_online` directory:  
Enter `ls`
6. Enter the following command:  
Enter `./install`

#### *Loading Online Manuals from the CDE File Manager*

To load *VnmrJ Online Manuals* this way, do the following steps:

1. Insert the *VnmrJ Online Manuals* CD-ROM.  
A CDE **File Manager – vnmrj\_online** window appears.
2. In the window, double-click on the install icon.  
A window opens showing progress statements. When installation is completed, a Done message appears.
3. Close the window.

## Ejecting the CD-ROM

When you are finished either installing the online manuals or reading them, eject the CD-ROM

*Using CDE File Manager*

1. Click **File** in the CDE **File Manager – vnmrj\_online** window
2. Click **Eject**.

*Using a Terminal Window Command Line:*

1. Enter `cd /`
2. Enter `eject cdrom`

## Linux® OS

These instructions apply to workstations running the Linux® Operating System.

- “Loading Online Manuals from a Terminal Console Window,” next
- “Ejecting the CD-ROM,” next

## Loading Online Manuals from a Terminal Console Window

To load *VnmrJ 1.1C–Online Manuals* this way, do the following steps:

1. Log in as `root` or use the `su` command to become root.  
*Do not switch user to root using `su -`.*
2. Insert the *VnmrJ Online Manuals* CD-ROM in the CD-ROM drive.  
If you are not `root` yet, the system asks you for the root password.
3. Open a terminal window.
4. Change to the `vnmrj_online` directory on the CD-ROM:  
Enter `cd /mnt/cdrom`
5. Look at the contents in the `vnmrj_online` directory:  
Enter `ls`
6. Enter the following command:  
Enter `./install`

## Ejecting the CD-ROM

When you are finished either installing the online manuals or reading them, you can eject the CD-ROM by entering the following commands in a terminal console window:

1. Enter `cd /`
2. Enter `eject cdrom`

## 2.6 Error Messages

- “Solaris OS,” next
- “Linux® OS,” page 27

### Solaris OS

- “Device Busy,” next
- ““Can’t connect to X11 window server,”” next
- “Locator Shows Only Error,” next
- “Missing Fonts,” next

### *Device Busy*

When you try to eject the CD-ROM and get the message:

```
/vol/dev/rdisk/c0t6d0/...: device busy
```

make sure that no window runs in which you have changed the directory to /cdrom/cdrom0. In such a case, do the following steps:

1. Exit the directory e.g.,  
user1> `cd /`
2. Click on **Run** windows and close all that use /cdrom/cdrom0.
3. Try ejecting the CD-ROM again.

### *“Can’t connect to X11 window server”*

```
Exception in thread "main"...Can't connect to X11 window server...
```

Enter `xhost +` in a window owned by the local user (not root).

### *Locator Shows Only Error*

If you see the message in the locator:

```
Error      Error      Error
```

Exit from VnmrJ and, as the VnmrJ administrator (not root), enter the following commands in a shell window:

```
vnmr1> /vnmr/bin/dbsetup
```

### *Missing Fonts*

When the VnmrJ `load.nmr` program (or any other Java program) starts, warning messages about missing fonts are generated if the Solaris package containing these fonts is not installed. A typical message might be:

```
Font specified in font.properties not found          \  
[-monotype-arial-bold-i-normal---*-%d---*--p---iso8859-1]
```

To install this package, insert the Solaris software CD (the first disk if there are two) and, as root, issue the following UNIX commands:

- For Solaris 9:  
# `cd /cdrom/cdrom0/s0/Solaris_9/Product/`

- ```
# pkgadd -d . SUNWilof
```
- For Solaris 8:

```
# cd /cdrom/cdrom0/s0/Solaris_8/Product/  
# pkgadd -d . SUNWilof
```
  - For Solaris 7:

```
# cd /cdrom/cdrom0/s0/Solaris_2.7/Product  
# pkgadd -d . SUNWilof
```

The specific directory containing the Solaris package depends on the version of Solaris. The `pkgadd` command is the same for all versions of Solaris. The name of the package has the digit one (1) in its name and not the letter *l*.

After the fonts have been installed, eject the CD-ROM.

You do not have to reboot the computer for this package to be activated.

## Linux® OS

There are no error messages related to the installation of VnmrJ at this time.



## Chapter 3. System Configuration

This chapter describes how to configure VnmrJ on your system. It includes the general, rf channel, and gradient configuration values for your system. Sections include:

- 3.1, “Ethernet Router Installation,” this page
- 3.2, “Setting Up the Host Computer for Data Acquisition,” on page 29
- 3.3, “Configuring Your System,” on page 30
- 3.4, “Creating the Acqproc User,” on page 40
- 3.5, “Setting the Lock Frequency,” on page 40
- 3.6, “Additional System Configurations,” on page 40
- 3.7, “Database Hints,” on page 41

### 3.1 Ethernet Router Installation

Some systems utilize a router to create a subnet. The *Varian Network Interface Installation* manual (01-999258-00) contains detailed router hookup and software installation instructions.

### 3.2 Setting Up the Host Computer for Data Acquisition

This section contains procedures that describe how to use the `setacq` command to establish communications between the host computer and the NMR console.

If you are installing a host computer for a data station or if you want to delay setting up for data acquisition, skip this chapter.

This section describes how to use the `setacq` command to establish the acquisition link between the Sun host computer and a <sup>UNITY</sup>*INOVA* or a *MERCURYplus/-Vx* console.

1. Make sure the host computer is connected to the console and the console is powered up.
2. Log in as `root`.
3. In a Terminal or Shell Tool, enter the following commands:

```
# cd /vnmr/bin
# ./setacq
```

If you are not logged in as `root`, the system asks for the root password.

**Expproc** will start and stop as needed

```
A message appears: One moment please ...
                    Killing Expproc
```

4. The following prompt appears:

```
Please reboot the console.
```

Enter a return after pressing the console reboot button:

On *UNITY INOVA*, reboot the console by momentarily pressing the SYST RST button on the acquisition CPU. Then press the **Return** or **Enter** key.

On *MERCURYplus/-Vx*, press the **reset** button (located behind the front door) momentarily.

5. The following prompt appears:

```
Please select from the options below:
```

1. Your SUN is attached to the console via the standard ethernet port
2. Your SUN is attached to the console via the second ethernet port.

```
What is your configuration? (1 or 2) [2]:
```

Answer **1** if only one Ethernet interface is present. Answer **2** if two Ethernet interfaces are present.

The `setacq` process may take several seconds, and finally responds with the following:

```
NMR Console software installation complete  
Starting Expproc
```

6. If needed, the system instructs you to reboot.

You must reboot Solaris for these changes to take effect

As root, reboot the Sun computer:

```
# reboot
```

If `setacq` repeatedly shows the message “Console timed-out, is it connected?”, check that the Ethernet connections between the host computer and the console are properly connected and reboot the console. If they are properly connected, use **Control-C** to stop the messages and return to the # prompt; then run `setacq` again.

Go to the next “[Configuring Your System](#)” on page 30 to finish installing VnmrJ.

### 3.3 Configuring Your System

After the VnmrJ software is installed, it must be configured using the VnmrJ configuration (CONFIG) tool.

1. Log in as the VnmrJ administrator (e.g., `vnmr1`) and start VnmrJ.
2. After VnmrJ starts, click on **Utilities** in the main menu, then **System Settings**. The (Experiment or Imaging) System settings window, shown in [Figure 6](#), opens. Use it to set various parameters.
3. In the window, click on the **System config** button. The VnmrJ CONFIG tool, similar to [Figure 7](#), opens.
4. If the **Use Console Data** button appears in the upper right of the CONFIG window, click it first.

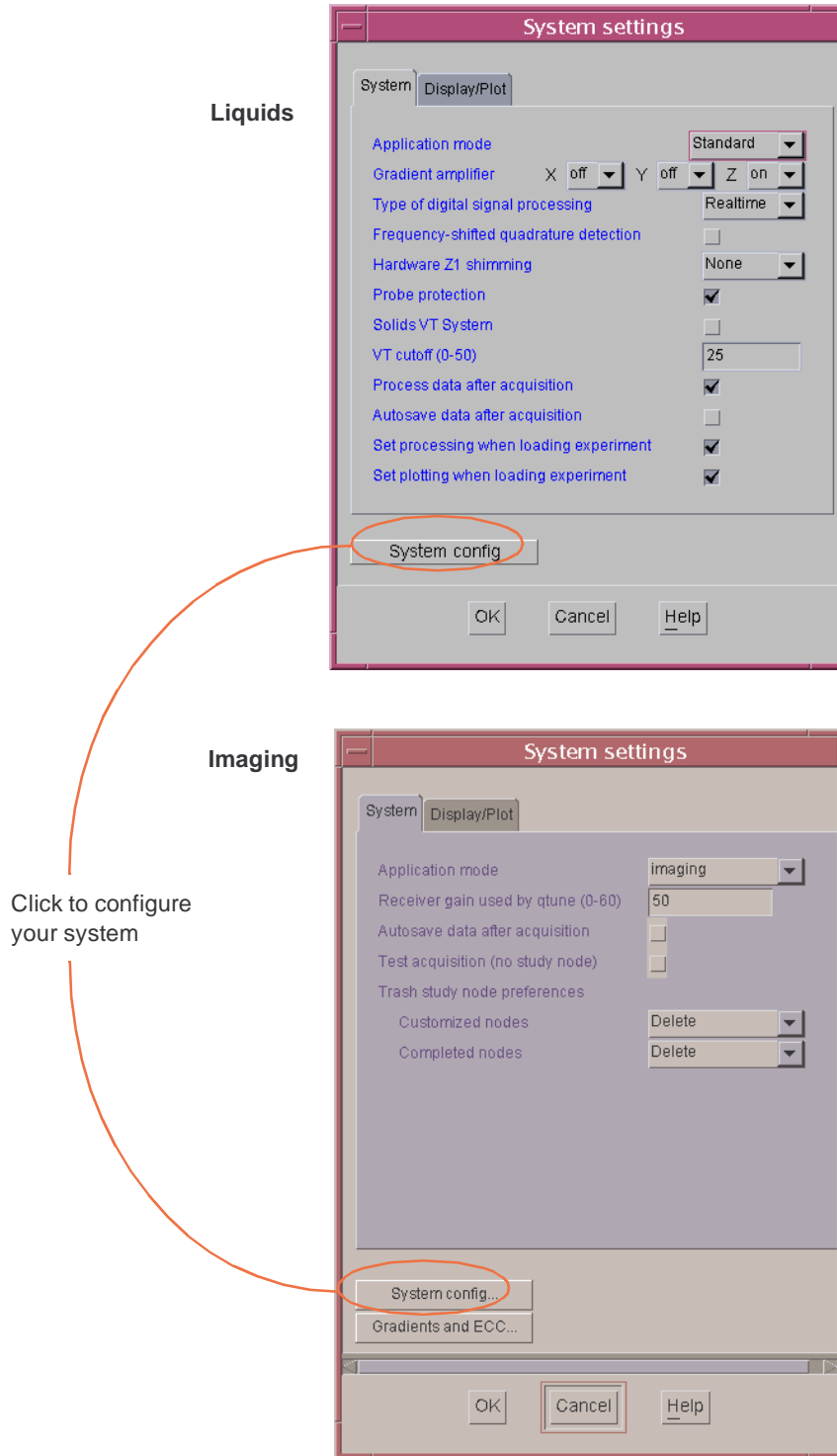

Figure 6. System Settings Windows



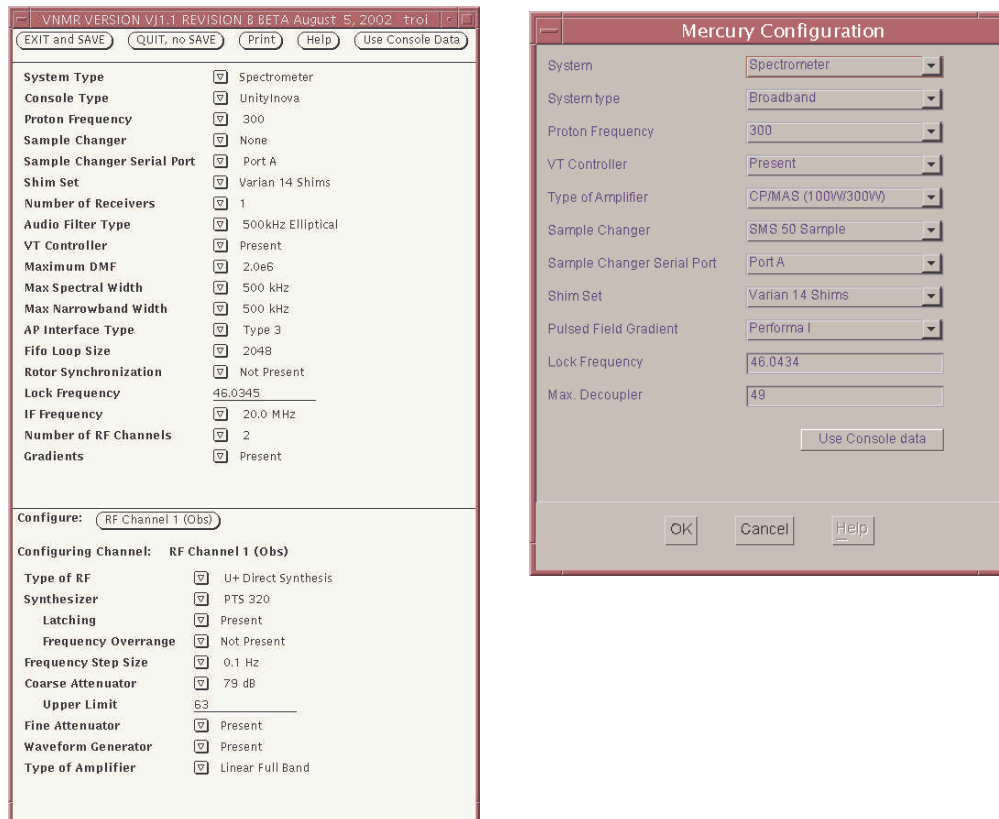

Figure 7. Configuration Tool

5. Check that the configuration values are correct for your system. For more information on these values, refer to the following tables:
  - Table 2, “General Configuration” on page 34
  - Table 3, “RF Channels Configuration” on page 36
  - Table 4, “Gradient Configuration” on page 37
  - Table 5, “MERCURYplus/-Vx Configuration” on page 38

For more information about config tool, see “About the CONFIG Tool” on page 39.

6. When you are satisfied with the configuration values, click on **EXIT and SAVE**. You must click on **EXIT and SAVE** even if you did not change any value. Then click **OK** to close the System settings window.
7. If you changed the system from a data station to a spectrometer, exit and restart VnmrJ to enable acquisition features in the main menu.

For special information about configuring NMR imaging systems, refer to the [Chapter 4, “Configuring NMR Imaging Systems”](#).

8. With left button of the mouse, click on the **Use Console Data** button.
9. Look through the list of labels and the current value of each in the center panel. For each label listed, take one of the following actions:
  - If the current value for a label is correct, make no change and continue to the next label.
  - Select the correct value in the menu.

Some items require entering a value directly from the keyboard. You can distinguish these because the value shows in normal video instead of inverse video. There is either a small diamond or a blinking solid triangle to the right of the current value. The blinking triangle means that item has been selected; it receives keyboard input. If not selected, move the mouse cursor into the panel containing the item and position it to the right of the displayed values in the blank area. Now click the left or middle button. The right button does not work here. The grey diamond becomes a solid triangle. Now enter the number followed by a carriage return. The solid triangle becomes a diamond again, indicating the program accepted the input. If a problem occurs, a message describing what is wrong appears in the panel and the bell sounds. The default value then appears. You must delete it using the **Delete** key before entering a new value.

10. Use [step 11](#) through [step 16](#) for <sup>UNITY</sup>INOVA only.
11. Check the labels and values in the lower panel (fourth) for each rf channel in your spectrometer. Start by seeing if the words “Configure: RF Channel 1 (Obs)” already appear in the third panel channel configuration menu. If they do, skip to [step 12](#).  
If another rf channel is listed, position the cursor on the words in the third panel, where you see the word “Configure”, and then press and hold down the right mouse button. A drop-down menu will appear. Move the mouse up or down to select RF Channel 1 (Obs), then release the mouse button.
12. Check that each label and value in the lower panel is correct for rf channel 1.
13. Now check the labels and values in the lower panel for the second rf channel in your spectrometer. Select rf channel 2 the same way you previously selected the first rf channel. Then check that each label and value in the lower panel is correct for rf channel 2. If you need help or are unsure of the meaning of a label, refer to the explanation given above.
14. If the system has a third rf channel, select it the same way you previously selected rf channel 1 and rf channel 2. Then check that each label and value in the lower panel is correct for rf channel 3. If you need help or are unsure of the meaning of a label, consult the explanations given above.  
You can only configure channel 3 if your system has the appropriate hardware and the Number of RF Channels label (in the second panel) is set to 3 or greater.
15. If the system has a fourth rf channel, select it the same way as previous channels. Then check that each label and value in the lower panel is correct for rf channel 4. If you need help or are unsure of the meaning of a label, consult the explanations above.  
You can only configure channel 4 if your system has the appropriate hardware and the Number of RF Channels label (in the second panel) is set to 4.
16. If the system has a waveform generator option with a gradient control unit, you need to check that the gradient values are correct. Position the mouse over the Configure button (in the channels/gradients configuration menu in the third panel) and click the left button until the label Gradients appears. In the lower panel, the labels X Axis, Y Axis, and Z Axis should appear. Check each label and value:
  - If the gradient is present for an axis, set the value to WFG+GCU.
  - If the PFG option is installed, set the value to Performa I or Performa II.
  - Otherwise, set the value for the axis to None.
 Up to three gradients can be present, one for each spatial axis.

**Table 2.** General Configuration

| <i>Label</i>                  | <i>Choices</i>                                                                                                                                                                                                                                                                                       | <i>Explanation</i>                                                                                                                                                                                                                                                                                                                                                                                                                                                                                                                                                                                                       |
|-------------------------------|------------------------------------------------------------------------------------------------------------------------------------------------------------------------------------------------------------------------------------------------------------------------------------------------------|--------------------------------------------------------------------------------------------------------------------------------------------------------------------------------------------------------------------------------------------------------------------------------------------------------------------------------------------------------------------------------------------------------------------------------------------------------------------------------------------------------------------------------------------------------------------------------------------------------------------------|
| System Type                   | Spectrometer,<br>Data Station                                                                                                                                                                                                                                                                        | Sets whether function of the workstation is to control a spectrometer or to operate as a separate data station. If Data Station is selected, VnmrJ does not allow acquisitions (the <code>go</code> command, its aliases, and related commands do not work).                                                                                                                                                                                                                                                                                                                                                             |
| Console Type                  | VXR-S, Unity,<br>UNITYPlus, UNITYINOVA,<br>SISCO Imager                                                                                                                                                                                                                                              | Sets spectrometer console type.                                                                                                                                                                                                                                                                                                                                                                                                                                                                                                                                                                                          |
| Proton Frequency              | 85, 100, 200, 300, 400,<br>500, 600, 700, 750, 800,<br>900, 3T, 4T                                                                                                                                                                                                                                   | Sets $^1\text{H}$ frequency for spectrometer-type systems.                                                                                                                                                                                                                                                                                                                                                                                                                                                                                                                                                               |
| Sample Changer                | None, Carousel, SMS 50<br>Sample, SMS 100 Sample,<br>VAST, NMS, LC-NMR,<br>768 AS                                                                                                                                                                                                                    | Sets the type of optional sample changer. Select <b>None</b> if no sample changer is present or, if a sample changer is attached, to disable its use.                                                                                                                                                                                                                                                                                                                                                                                                                                                                    |
| Sample Changer<br>Serial Port | Not Used, Port A,<br>Port B                                                                                                                                                                                                                                                                          | Sets serial port used for the sample changer. Select <b>Not Used</b> if no sample changer is present.                                                                                                                                                                                                                                                                                                                                                                                                                                                                                                                    |
| Shim Set                      | Varian 13 Shims,<br>Varian 14 Shims,<br>Oxford 15 Shims,<br>Oxford 18 Shims,<br>Varian 18 Shims,<br>Varian 20 Shims,<br>Varian 23 Shims,<br>Varian 26 Shims<br>Varian 28 Shims,<br>Varian 29 Shims,<br>Varian 35 Shims,<br>Varian 40 Shims,<br>Ultra 18 Shims,<br>Ultra 35 Shims<br>Whole Body Shims | Sets type of shims on the system.                                                                                                                                                                                                                                                                                                                                                                                                                                                                                                                                                                                        |
| Number of<br>Receivers        | 1, 2, or 4                                                                                                                                                                                                                                                                                           | Sets the number of receivers available in the system.                                                                                                                                                                                                                                                                                                                                                                                                                                                                                                                                                                    |
| Audio Filter Type             | 100kHz Elliptical,<br>100kHz Butterworth,<br>200kHz Butterworth,<br>500kHz Elliptical                                                                                                                                                                                                                | Sets type of audio filter in the system: 8-pole quasi-elliptical filter or 4-pole Butterworth.                                                                                                                                                                                                                                                                                                                                                                                                                                                                                                                           |
| VT Controller                 | Not Present, Present                                                                                                                                                                                                                                                                                 | Sets whether a VT controller is present.                                                                                                                                                                                                                                                                                                                                                                                                                                                                                                                                                                                 |
| Maximum DMF                   | 9900, 32700, 2.0e6                                                                                                                                                                                                                                                                                   | DMF is used with WALTZ, GARP, XY32, MLEV16, <code>fm-fm</code> , and <code>squarewave</code> . Set DMF to 2.0e6.<br><br>An alternate method to find the maximum DMF value is to use NMR: Set the maximum DMF to 32700, then set up a $^{13}\text{C}$ experiment with the parameter <code>dmf</code> arrayed with values of 9900 and 10000.<br><br>If your hardware allows <code>dmf</code> greater than 9900, the two spectra should be essentially identical. If not, the second spectrum should show significantly worse decoupling. If that is the case, go back to <code>conf ig</code> and set Maximum DMF to 9900. |

**Table 2.** General Configuration (continued)

| <i>Label</i>          | <i>Choices</i>                                               | <i>Explanation</i>                                                                                                                                                                                                                                                                                                                                                                                                                                                                                                                                                                                                                          |
|-----------------------|--------------------------------------------------------------|---------------------------------------------------------------------------------------------------------------------------------------------------------------------------------------------------------------------------------------------------------------------------------------------------------------------------------------------------------------------------------------------------------------------------------------------------------------------------------------------------------------------------------------------------------------------------------------------------------------------------------------------|
| Max Spectral Width    | 100 kHz, 200 kHz, 500 kHz, 2 MHz, 5 MHz                      | Set to 500 kHz for UNITY INOVA. Set to 100 kHz for systems with standard ADC. Set to 2 or 5 MHz for systems with Wideband NMR Module accessory.                                                                                                                                                                                                                                                                                                                                                                                                                                                                                             |
| Max Narrowband Width  | 100 kHz, 200 kHz, 500kHz                                     | Defines maximum spectral width of the Input board.                                                                                                                                                                                                                                                                                                                                                                                                                                                                                                                                                                                          |
| AP Interface Type     | Type 1, Type 2, Type 3, N/A                                  | AP Interface Type is not applicable.                                                                                                                                                                                                                                                                                                                                                                                                                                                                                                                                                                                                        |
| Fifo Loop Size        | 63, 1024, 2048                                               | Set to 2048.                                                                                                                                                                                                                                                                                                                                                                                                                                                                                                                                                                                                                                |
| Rotor Synchronization | Not Present, Present                                         | Set to <b>Present</b> if system has the optional solids rotor synchronization accessory; else set to <b>Not Present</b> . This accessory requires the Acquisition Controller board (Part No. 00-969204-0x), Pulse Sequence Controller board (00-992560-0x), or Digital Acquisition Controller board (01-902022-00).                                                                                                                                                                                                                                                                                                                         |
| Lock Frequency        | 1 Hz to 160 MHz, in 0.1 Hz steps (enter the number directly) | The value should be the same as found in the procedure in section 3.5, “ <b>Setting the Lock Frequency,</b> ” on page 40, which is the nominal $^2\text{H}$ observe frequency.<br><b>To observe NMR signals, the value of Lock Frequency must be set correctly.</b>                                                                                                                                                                                                                                                                                                                                                                         |
| IF Frequency          | 10.5 MHz, 20.0 MHz                                           | Select the intermediate frequency (I.F.) of your system.                                                                                                                                                                                                                                                                                                                                                                                                                                                                                                                                                                                    |
| Number of RF Channels | 1, 2, 3, 4, 5                                                | Sets number of rf channels available (the lock channel is not included). Systems normally have 2, 3, or 4 rf channels: The first channel is for direct observation. The second channel allows decoupling or pulsing when decoupling. An optional third channel allows decoupling of a second nucleus. An optional fourth channel allows decoupling of a third nucleus. The minimum value you can select is 2. <i>Do not change this value to eliminate the use of a channel.</i> For information on how to disable a channel, refer to the descriptions of the parameters dn2 and dn3 in the <i>VnmrJ Command and Parameter Reference</i> . |
| Gradients             | Not Present, Present                                         | Set to <b>Present</b> if your system has optional gradients for the X, Y, Z axis, or an Imaging Gradient Coil. If Gradients is set to <b>Present</b> , go to the gradient channel configuration menu (Table 4) to configure the gradients.                                                                                                                                                                                                                                                                                                                                                                                                  |

**Table 3.** RF Channels Configuration

| <i>Label</i>        | <i>Choices</i>                                                                                                                     | <i>Explanation</i>                                                                                                                                                                                                                                                                                                                                                                                                                                                                                                                                                            |
|---------------------|------------------------------------------------------------------------------------------------------------------------------------|-------------------------------------------------------------------------------------------------------------------------------------------------------------------------------------------------------------------------------------------------------------------------------------------------------------------------------------------------------------------------------------------------------------------------------------------------------------------------------------------------------------------------------------------------------------------------------|
| Configuring Channel | RF Channel 1 (Obs),<br>RF Channel 2 (Dec),<br>RF Channel 3 (Dec2),<br>RF Channel 4 (Dec3),<br>RF Channel 5 (Dec4),<br>Gradients    | Shows which rf channel is the current channel for the purposes of configuration. This item is present for information only; the value cannot be changed.                                                                                                                                                                                                                                                                                                                                                                                                                      |
| Type of RF          | U+ Direct Synthesis,<br>U+ H1 Only,<br>Deuterium Decoupler<br>Direct Synthesis,<br>Broadband,<br>Fixed Frequency,<br>SIS Modulator | Sets type of rf generation on the current rf channel. Direct Synthesis uses the frequency directly from the frequency synthesizer with no mixing (also called rf type C). Broadband mixes the output from a frequency synthesizer with a fixed frequency source to generate the desired frequency (also called rf type B). Fixed Frequency uses rf generated from fixed frequency sources (also called rf type A). Select U+ Direct Synthesis or U+ 1H Only.                                                                                                                  |
| Synthesizer         | Not Present, PTS160,<br>PTS200, PTS250,<br>PTS320, PTS500,<br>PTS620, PTS1000                                                      | Sets the model of the PTS frequency synthesizer if present on the current rf channel. The model number is written on the front of the synthesizer. To make a selection for the Decoupler RF Channel with a fixed-frequency decoupler, select PTS*** for RF channels 1 and 2 (and all others, if present), where *** is the number written on the front of the synthesizer.                                                                                                                                                                                                    |
| Latching            | Not Present, Present                                                                                                               | Sets whether current rf channel has a PTS frequency synthesizer with latching capabilities (all digits of the frequency value are sent to the synthesizer at once). All synthesizers have latching capabilities, and Latching is always set to <b>Present</b> .                                                                                                                                                                                                                                                                                                               |
| Frequency Overrange | Not Present, 10000 Hz,<br>100000 Hz                                                                                                | Sets whether current channel has special version X46 of PTS frequency synthesizer in which the signal phase is stable over a larger range of frequencies than the standard synthesizer. If Frequency Overrange is set to 10000 or 100000, Latching must also be set to <b>Present</b> .<br>To determine the overrange value for a PTS 320, look at the fifth character in the serial number—it will be <i>H</i> , <i>J</i> , or <i>K</i> . For <i>H</i> , set 100000 (0.1 resolution); For <i>J</i> , set 100000 (1:0 resolution); for <i>K</i> , set 10000 (0.1 resolution). |
| Frequency Step Size | 0.1 Hz, 0.2 Hz, 1 Hz,<br>100 Hz                                                                                                    | Sets step size in the offset synthesizer (rf type A or B) or the PTS synthesizer on the current rf channel. If two channels have an offset synthesizer, one channel must have a step size of 100 Hz. If at least one channel has direct synthesis, the observe and decouple channels can have the 0.1 Hz step size. The 0.2 Hz choice is included because some PTS synthesizers have only 0.2 Hz resolution.                                                                                                                                                                  |
| Coarse Attenuator   | Not Present, 63 dB,<br>79 dB, 63.5 dB (SIS)                                                                                        | Sets type of coarse attenuator if present on current rf channel. Set to <b>Not Present</b> if no coarse attenuator, as in the case of class C amplifiers. Set to 79 dB for a 79-dB attenuator (standard on <sup>UNITY</sup> INOVA).                                                                                                                                                                                                                                                                                                                                           |

**Table 3.** RF Channels Configuration (continued)

| <i>Label</i>       | <i>Choices</i>                                                                              | <i>Explanation</i>                                                                                                                                                                                                                                                                                                                                                                                                                                                                                                                                                                                                                                                                                                                                                                                         |
|--------------------|---------------------------------------------------------------------------------------------|------------------------------------------------------------------------------------------------------------------------------------------------------------------------------------------------------------------------------------------------------------------------------------------------------------------------------------------------------------------------------------------------------------------------------------------------------------------------------------------------------------------------------------------------------------------------------------------------------------------------------------------------------------------------------------------------------------------------------------------------------------------------------------------------------------|
| Upper Limit        | 0 to 63 for 63-dB attenuator, or –16 to 63 for 79-dB attenuator (enter the number directly) | Sets an upper limit to the current rf channel to prevent damage from high power rf. The decoupler channel is usually set to 45 or 50 to prevent damage to the probe. On horizontal NMR imaging systems, enter 127.                                                                                                                                                                                                                                                                                                                                                                                                                                                                                                                                                                                         |
| Fine Attenuator    | Not Present, Present                                                                        | Sets whether current rf channel has a fine attenuator. Typically only the first two rf channels can have a fine attenuator. All channels must have this label set to <b>Present</b> .                                                                                                                                                                                                                                                                                                                                                                                                                                                                                                                                                                                                                      |
| Waveform Generator | Not Present, Present                                                                        | Sets whether current rf channel has a waveform generator.                                                                                                                                                                                                                                                                                                                                                                                                                                                                                                                                                                                                                                                                                                                                                  |
| Type of Amplifier  | Class C, Linear Full band, Linear Low band, Linear Broadband, Shared                        | Sets type of amplifier on the current rf channel. Class C indicates the channel uses a class C amplifier. Linear Full Band indicates the channel uses a linear full-band amplifier. Linear Low Band indicates the channel uses a linear low-band amplifier. Shared means that the amplifier is fully declared with the third channel, and that the fourth channel shares this amplifier with the third channel. Linear Broadband indicates the channel goes to one amplifier for all frequencies, which is the usual selection from <sup>UNITY</sup> INOVA horizontal NMR imaging systems. Contact your field service engineer if you have any questions about what class amplifiers are in your system. Refer to the <code>amptype</code> parameter in the <i>VnmrJ Command and Parameter Reference</i> . |

**Table 4.** Gradient Configuration

| <i>Label</i>          | <i>Choices</i>                                                                                                                                        | <i>Explanation</i>                                                                                                                                                                                                                                                                                                                                                                                                                                                            |
|-----------------------|-------------------------------------------------------------------------------------------------------------------------------------------------------|-------------------------------------------------------------------------------------------------------------------------------------------------------------------------------------------------------------------------------------------------------------------------------------------------------------------------------------------------------------------------------------------------------------------------------------------------------------------------------|
| X Axis                | None, WFG+GCU, Gradient Coordinate Rotator, Performa I, Performa II/III, Performa II/III+WFG, Performa XYZ, Performa XYZ+WFG, SIS (12 bit), Homospoil | Sets value of the spatial axis. If the system has a waveform generator option with a gradient control unit, check the gradient values are correct next to the labels X Axis, Y Axis, and Z Axis. If the gradient is present for an axis, set the value to WFG+GCU. If the PFG option is installed, set the value to Performa I, Performa II, or Performa III; otherwise, set the value for the axis to None. Up to three gradients can be present, one for each spatial axis. |
| Y Axis                | Same choices as X Axis.                                                                                                                               | Same explanation as X Axis.                                                                                                                                                                                                                                                                                                                                                                                                                                                   |
| Z Axis                | Same choices as X Axis, Homospoil                                                                                                                     | Same explanation as X Axis. Homospoil is functional only for the Z axis.                                                                                                                                                                                                                                                                                                                                                                                                      |
| Imaging Gradient Coil | None, Main, . . .                                                                                                                                     | Selects the gradient coil configuration file that defines the current installed gradient coil ( <code>sysgcoil</code> ).                                                                                                                                                                                                                                                                                                                                                      |

**Table 5.** *MERCURYplus/-Vx* Configuration

| <i>Parameters<sup>1</sup></i> | <i>Values</i>                                                    | <i>Descriptions</i>                                                                                                                                                                                                                                                                                                                                                                                                                                                                                                                                                                                                                                                                    |
|-------------------------------|------------------------------------------------------------------|----------------------------------------------------------------------------------------------------------------------------------------------------------------------------------------------------------------------------------------------------------------------------------------------------------------------------------------------------------------------------------------------------------------------------------------------------------------------------------------------------------------------------------------------------------------------------------------------------------------------------------------------------------------------------------------|
| System                        | Spectrometer, Data Station                                       | Sets whether function of the workstation is to control a spectrometer or to operate as a separate data station. If Data Station is selected, VnmrJ does not allow acquisitions (the <code>go</code> command, its aliases, and related commands do not work).                                                                                                                                                                                                                                                                                                                                                                                                                           |
| System Type                   | 4-Nucleus, Broadband                                             | Sets whether the function of the workstation is to control a 4-Nucleus <i>MERCURYplus/-Vx</i> NMR spectrometer or a Broadband <i>MERCURYplus/-Vx</i> NMR spectrometer.<br>Effective June 2000, the <i>MERCURY-VX</i> 300-MHz 4-Nucleus system uses the Hi/Lo Reference Generator board. For this system, in CONFIG window set System Type to Broadband ( <code>rf type= 'fe'</code> ).<br>If the board type is unknown, look at the rf card cage in the back of the console. The third rf board from the left is the reference generator. If the top of the board is labeled Hi/Lo, select Broadband, but if it is labeled 4-Nucleus or 5-Nucleus select 4-Nucleus as the system type. |
| Proton Frequency              | 200, 300, 400                                                    | Sets the proton frequency for spectrometer-type systems.                                                                                                                                                                                                                                                                                                                                                                                                                                                                                                                                                                                                                               |
| VT Controller                 | Not Present, Present                                             | Sets whether the VT controller is present                                                                                                                                                                                                                                                                                                                                                                                                                                                                                                                                                                                                                                              |
| Type of Amplifier             | aa, bb, cc                                                       | Specifies the type of amplifier. aa indicates 4-Nucleus, bb indicates broadband, cc indicates CP/MAS.                                                                                                                                                                                                                                                                                                                                                                                                                                                                                                                                                                                  |
| Sample Changer                | None, Carousel, SMS 50 Sample, SMS 100 Sample, VAST, NMS, LC-NMR | Sets the type of optional sample changer. Select <b>None</b> if no sample changer is present or, if a sample changer is attached, to disable its use.                                                                                                                                                                                                                                                                                                                                                                                                                                                                                                                                  |
| Sample Changer Serial Port    | Not Used, Port A, Port B                                         | Sets serial port used for the sample changer. Select <b>Not Used</b> if no sample changer is present.                                                                                                                                                                                                                                                                                                                                                                                                                                                                                                                                                                                  |
| Shim Set                      | Varian 14 Shims, Varian 18 Shims, Varian 23 Shims,               | Sets type of shims on the system.                                                                                                                                                                                                                                                                                                                                                                                                                                                                                                                                                                                                                                                      |
| Pulsed Field Gradient         | Not Present, Homospoil, Performa I, Performa II                  | Sets whether the optional pulsed field gradient (PFG) hardware is present. Homospoil is always present and can be used for gradient shimming and homospoil; It does not work with gradient experiments, such as gHMQC.                                                                                                                                                                                                                                                                                                                                                                                                                                                                 |
| Lock Frequency                | 1 MHz to 160 MHz, in 0.1 Hz steps (entered directly)             | The <sup>2</sup> H observe frequency. It is used to set the lock transmitter frequency.<br><b>To observe NMR signals, the value of Lock Frequency must be set correctly.</b>                                                                                                                                                                                                                                                                                                                                                                                                                                                                                                           |
| Max. Decoupler                | 0 to 63 dB, in steps of steps of 1 dB. Usually less than 50.     | This value is normally limited to 50 because a higher-power, continuous-decoupling can damage the probe. You can increase the maximum power, cautiously.                                                                                                                                                                                                                                                                                                                                                                                                                                                                                                                               |

1. Several other system-wide parameters are set automatically.

## About the CONFIG Tool

The VnmrJ CONFIG tool, shown in [Figure 7](#), is the interface with the system global configuration parameter file `conpar`. Only one copy of `conpar` exists on each spectrometer, and all users of VnmrJ share this copy. As the software is shipped, only the VnmrJ administrator can make changes to configuration parameters using the CONFIG tool in the interactive mode (refer to the description of the `config` command in the *VnmrJ Command and Parameter Reference* for information about `config` modes, `conpar` parameters, and additional information about using `config`).

The CONFIG tool has two or four panels: command buttons in the top panel, a list of labels and their current values generally applicable to all systems in the second panel, a channels/gradients configuration menu in the third panel, and a list of labels and for UNITY-series values pertaining to rf channels (and gradients if the system contains this option) in the bottom panel.

To select a command from the buttons in the top of the tool, place the mouse cursor over the desired button, then press and release the left mouse button. The buttons have the following actions:

|                  |                                                                                                                                                                                                                                                                                                                                                                                                                                                                                                                                                                                                                                                                                                                                                                                                                                                                             |
|------------------|-----------------------------------------------------------------------------------------------------------------------------------------------------------------------------------------------------------------------------------------------------------------------------------------------------------------------------------------------------------------------------------------------------------------------------------------------------------------------------------------------------------------------------------------------------------------------------------------------------------------------------------------------------------------------------------------------------------------------------------------------------------------------------------------------------------------------------------------------------------------------------|
| Exit and Save    | Saves all the changes made since opening CONFIG to a new version of the <code>conpar</code> file, then closes CONFIG. Note that because the old version of <code>conpar</code> is overwritten, you might want to back up the <code>conpar</code> file before starting CONFIG.                                                                                                                                                                                                                                                                                                                                                                                                                                                                                                                                                                                               |
| Quit, No Save    | Closes CONFIG without saving any of the changes made since opening the program                                                                                                                                                                                                                                                                                                                                                                                                                                                                                                                                                                                                                                                                                                                                                                                              |
| Print            | Prints the current window of the VnmrJ CONFIG tool. Keep in mind that if you make further changes before quitting or quit <code>config</code> without saving the changes, the printout might not have the same values for parameters as is in the <code>conpar</code> file.                                                                                                                                                                                                                                                                                                                                                                                                                                                                                                                                                                                                 |
| Help             | Opens a scrollable window with information about <code>config</code> .                                                                                                                                                                                                                                                                                                                                                                                                                                                                                                                                                                                                                                                                                                                                                                                                      |
| Use Console Data | On <sup>UNITY</sup> INOVA systems, this button makes <code>config</code> capture from the system all values except Sample Changer, Rotor Synchronization, Frequency Overrange, and the Upper Limit of decoupler power. For <sup>UNITY</sup> INOVA only, in the Gradients entry, <code>config</code> recognizes Performa I and Performa II, but other gradients are not recognized. For the VT Controller entry, if VT is found, <code>config</code> does not change the value set, and if VT is not found, <code>config</code> changes the value to Not Present.<br>On MERCURYplus/-Vx systems, this button captures for the system all values except sample changer and sample changer port. For the VT Controller entry, if VT is found, <code>config</code> does not change the value set, and if VT is not found, <code>config</code> changes the value to Not Present. |



### 3.4 Creating the Acqproc User

On systems that include a magnet installation (spectrometers systems, not data stations), a series of daemons, known as the proc-family, direct communications between the host computer and the console.

If you want all your users to be able to enable and disable these daemons, become `root` and type the following command:

```
# /vnmr/bin/makesuacqproc
```

If you are not `root` yet, the system asks you for your `root` passwords.

Now all users can enable or disable the daemons by typing the following command:

```
user> su acqproc
```

### 3.5 Setting the Lock Frequency

On system installations that include installing a magnet, the lock frequency must be set with the following procedure after VnmrJ is installed. The true  $^2\text{H}$  frequency is used. This procedure is not normally done again unless the magnet quenches or a large change in field strength occurs.

1. Make sure the magnet is “at field.”
2. If a water sample is not in the magnet, insert it. This can be tap water.
3. Set `sw=100000` for *MERCURYplus/-Vx*, (`sw=500000` if *UnityINOVA*), or `sw=2000000` if *wideline*).
4. Set `tn='H1' lockfreq='n'`.
5. Enter `ga`. If you don't see any peaks, the system is off resonance.  
By changing the value of `tof` (or array `tof`), locate the water resonance. Make the change 200-kHz- to 400-kHz for *UNITYINOVA*, 80-kHz- to 100-kHz for *MERCURYplus/-Vx* so each spectral window will overlap its neighbors.
6. Center the water resonance you located in the spectral window by placing the cursor on the line and entering `movetof`.
7. Acquire a spectrum with the line centered in the window.
8. Enter the command `setlockfreq`.  
`setlockfreq` calculates and sets the lock frequency parameter `lockfreq`.

### 3.6 Additional System Configurations

You have completed VnmrJ software installation and configuration.

- The preceding procedures permit only the database owner (e.g., user `vnmr1`) to access the VnmrJ interface. The database owner is the same as the VnmrJ administrator. If you want to **create other VnmrJ users**, see [Chapter 5, “VnmrJ - Administration”](#).
- For special information about **configuring NMR imaging systems**, refer to [Chapter 4, “Configuring NMR Imaging Systems,”](#) on page 43.
- To **set up a printer or plotter**, refer to [“Managing Printers and Plotters”](#) on page 62 for information.

## 3.7 Database Hints

If the Locator shows **Error** under the column headings, or if the error message `DataBase contents version is not correct . . .` appears on the bottom of the screen, exit VnmrJ and run **dbsetup** in a terminal window.



## Chapter 4. Configuring NMR Imaging Systems

This chapter describes how to configure an NMR system for imaging. Sections in this chapter:

- 4.1, “Verifying Imaging Software is Installed,” this page
- 4.2, “Setting the User Interface Type,” on page 43
- 4.3, “Setting Viewports and Data Saving,” on page 44

### 4.1 Verifying Imaging Software is Installed

The imaging software must be installed before configuring an NMR system for imaging. The software includes macros, menus, parameters, and executables used for imaging. If the option **Imaging\_or\_Triax** was checked in **General options** during VnmrJ installation (see “[Configuring Your System](#)”, page 30), the imaging software is installed. Usually **Imaging\_Sequences** under **Password options** is also installed. To verify that the imaging software was installed, check the following directory:

```
ls /vnmr/imaging
```

If the `decclib`, `eddylib`, `gradtables`, `shuffler`, and `templates` directories are listed, the imaging software is loaded. If the software is not present, follow the procedure in section [Chapter 2, “VnmrJ Installation,”](#) on page 19, but check only **Imaging\_or\_Triax**. Optionally check **Imaging\_Sequences**, which requires a password.

### 4.2 Setting the User Interface Type

In order for a VnmrJ user to have access to the imaging software, you must create the user as an imaging experiment type (or imager). To create an imaging user, do the following steps using the VnmrJ Admin window to set the user interface type to imaging:

1. Log in as **vnmr1** and enter **vnmrj adm** in a Terminal window.
2. In the VnmrJ Admin window ([Figure 8](#)):
  - a. Click on **vnmr1** to select the account.
  - b. Set the **Interface Type** to **Imaging**
  - c. Check configuration default for path.
  - d. Click **Save User**.
  - e. Exit VnmrJ Admin.

For further details on how to create and configure other users, see section “[Adminstrating User Accounts](#)”, page 48.

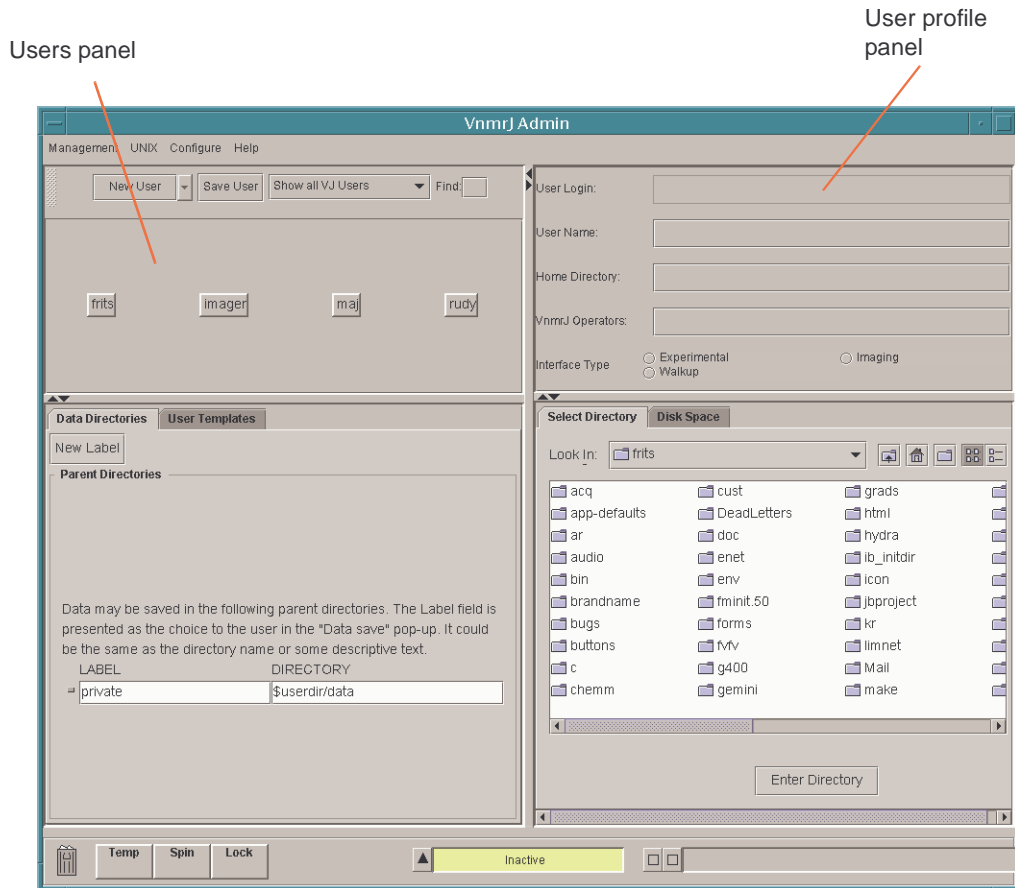

Figure 8. VnmrJ Admin Window

### 4.3 Setting Viewports and Data Saving

1. If VnmrJ not started, enter `vnmrj` in the Terminal window, or click on the VnmrJ icon in the CDE toolbar.
2. Select **Viewports** from the **Edit** menu. Click **Set 3 Default Viewports** and click **OK**.
3. Select **Utilities** -> **Save data** -> **Save data setup**. Change as necessary (the defaults are OK), and click **OK**.

# Chapter 5. VnmrJ - Administration

Sections in this chapter:

- 5.1 “VnmrJ Admin Interface,” this page
- 5.2 “VnmrJ Account Interfaces,” page 47
- 5.3 “Administrating User Accounts,” page 48
- 5.4 “Viewing the Unix File System,” page 60
- 5.5 “Setting Up Investigator List,” page 61
- 5.6 “Setting Up Automation Queue,” page 61
- 5.7 “Managing Printers and Plotters,” page 62
- 5.8 “Setting Up DICOM Storage,” page 66
- 5.9 “Setting Background Colors,” page 66

## 5.1 VnmrJ Admin Interface

- “Starting VnmrJ Adm and the VnmrJ Admin Interface,” next
- “VnmrJ Admin Menu Bar,” next
- “Selecting Items,” page 46

### Starting VnmrJ Adm and the VnmrJ Admin Interface

1. Login to the workstation using the VnmrJ administrator user account or open a terminal window and change users to the VnmrJ administrator account.
2. Type `vnmrj adm` on at the prompt to start VnmrJ Admin and open the VnmrJ Admin window, see **Figure 9**.

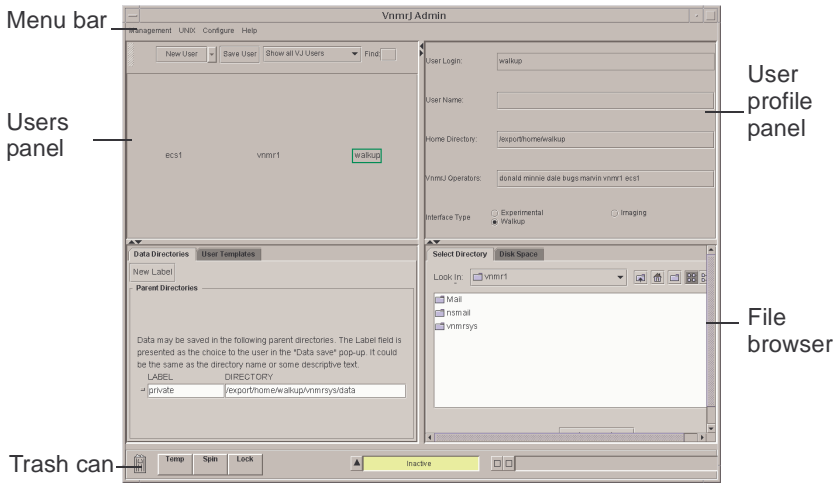

Figure 9. VnmrJ Administrator Window

## VnmrJ Admin Menu Bar

Select administration functions from the menu bar.

Management UNIX Configure Help

- **Management:**
  - Users...** Displays users in the users panel and makes available all the administrative functions needed to create, delete, and manage user accounts, refer to [“Administering User Accounts,”](#) page 48.
  - Printers** — select additional functions using popup window, refer to [“Managing Printers and Plotters,”](#) page 62 manual for more information and instructions.
  - Cost Accounting** — refer to Chapter 6 [“VnmrJ-Accounting Administration,”](#) page 69.
  - Exit**— exit and close VnmrJ Admin
- **UNIX**
  - File System** — popup window displays file system information, refer to [“Viewing the Unix File System,”](#) page 60 for more information and instructions.
  - Command window** — opens a UNIX terminal window
- **Configure**
  - Users** — select additional functions using popup window:
    - **Convert users** ... [“Converting User Accounts to VnmrJ,”](#) page 55
    - **Defaults...** see [“Setting User Account Defaults,”](#) page 58
    - **Update users...** [“Updating User Accounts,”](#) page 56
  - Operators** — add operators to the walkup account, see [“Walkup Operator,”](#) page 47
    - **Edit operators...**, see [“Adding Operators to a User Account,”](#) page 51
    - **Delete operators...**, see [“Deleting Operators from User Accounts,”](#) page 53
    - **Reset password...**, see [“Resetting Operator Password,”](#) page 53
    - **Preferences...**, see [“Setting Operator Preferences,”](#) page 51
  - Automation**— set up automation queue options using this popup window, see [“Setting Up Automation Queue,”](#) page 61 .
  - Investigator List**...Enter investigators in the popup window, refer to [“Setting Up Investigator List,”](#) page 61.
  - DICOM Storage** — Configure the dicom storage device – refer to 5.8 [“Setting Up DICOM Storage,”](#) page 66 and the VnmrJ on-line help for setup instructions.
  - Background Colors**— select additional functions using popup window, refer to [“Setting Background Colors,”](#) page 66 for more information and instructions.
- **Help**— select type of help, a browser will start with help topics.
  - VnmrJ Help...**
  - Admin Help...**

## Selecting Items

Various administration functions need to be applied to multiple items or accounts. The instructions for account administration in this section are applied by selecting a single account or item. Multiple items or accounts can be selected by holding the Shift and Ctrl keys down while selecting each item. Clicking on a selected item a second time removes it from the list of selected items.

## 5.2 VnmrJ Account Interfaces

Each VnmrJ account can be set up with an interface and privileges that are appropriate for the needs of the user.

### *Experimental*

The VnmrJ user requiring the full range of flexibility and experimental capabilities is typically set up with the Experimental interface.

### *Walkup*

The walkup interface is designed for automated operation with a sample changer and for operation in an open access environment. There are two levels, the UNIX walkup account owner and the operator level.

- Walkup Account owner

The walkup administrator is the UNIX login and therefore the owner of the account and any automation runs started while logged in. All default operations that occur during an automation run (shimming, locking, etc.) are set up by this user before the automation run is started. Refer to the manual VnmrJ Walkup for a full description of the Walkup interface the administrator account functions.

- Walkup Operator

The walkup operator has VnmrJ access via a user name and password and is not a UNIX login (the operator may have UNIX level privileges for other accounts) and therefore does not own any of the files in the account. All default operations that occur during an automation run (shimming, locking, etc.) are first set up by the walkup administrator before the automation run is started. Refer to the manual VnmrJ Walkup for a full description of the Walkup interface the operator account functions.

### *Imaging*

The imaging interface provides the user with the full range of functions necessary for the acquisition of MRI data, design imaging sequences, build study protocols, and process and imaging data.



## 5.3 Administrating User Accounts

User accounts are created or set up from the VnmrJ Admin interface. A typical administration function is setting up new accounts and configuration of the VnmrJ interface according to the user's needs, see [“VnmrJ Account Interfaces,” page 47](#). Another administrative function is assigning group of operators to a single user account — typically, for a non-imaging system, the user and operators are working with a system that has an automated sample changer system, see [“VnmrJ Account Interfaces,” page 47](#). The overall automation is administrated by the Walkup administer (logged in as the current UNIX and VnmrJ user), refer to the *VnmrJ Walkup* manual for operation and interface descriptions.

### VnmrJ Administrator User Account Management Functions:

- [“Setting up a New User Account,” page 48](#)
- [“Setting up Multiple New User Accounts,” page 49](#)
- [“Changing the Interface of a User Account,” page 50](#)
- [“Setting Operator Preferences,” page 51](#)
- [“Adding Operators to a User Account,” page 51](#)
- [“Resetting Operator Password,” page 53](#)
- [“Deleting Operators from User Accounts,” page 53](#)
- [“Deleting a User Account,” page 54](#)
- [“Restoring a User Account,” page 55](#)
- [“Converting User Accounts to VnmrJ,” page 55](#)
- [“Updating User Accounts,” page 56](#)
- [“VnmrJ Account Interfaces,” page 47](#)
- [“Setting User Templates, Directories, and Defaults,” page 58](#)

### Setting up a New User Account

The new user account will be set up using the default values set in User Account Defaults, see [“Setting User Account Defaults,” page 58](#).

Start the *VnmrJ Adm* interface

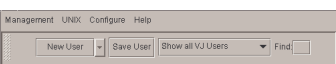
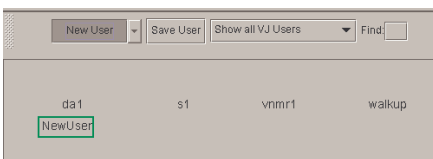
| <i>Instruction</i>                                                          | <i>Window</i>                                                                        |
|-----------------------------------------------------------------------------|--------------------------------------------------------------------------------------|
| Click on <b>Management</b> on the menu bar.                                 |  |
| Select <b>Users</b> from the drop down menu.                                |                                                                                      |
| Select <b>Show all VJ Users</b> from the drop down menu in the Users Panel. |  |
| Click on <b>New User</b> in Users Panel drop down menu.                     |                                                                                      |
| Displayed in the Users Panel is NewUser with a box around it.               |  |

**Instruction****Window**

The account's profile is displayed in the User Profile Panel.

There are five sections to this panel (by default, to view other fields, data dir etc., see user defaults: "Setting User Account Defaults," page 58

**User Login:** — Enter login name and press 'RETURN' prompt is displayed in the user login field.

**User Name:** — Optional. Enter a user name

**Home Directory** — Will be automatically setup (new users - no UNIX account) based upon the user defaults (see "Setting User Account Defaults," page 58) or, if the user was first set up as a UNIX account, the user's UNIX account home directory is used.

**VnmrJ Operators** — Optional. List other users with VnmrJ operation privileges (Walkup only).

**Interface Type** — click on the radio button to select Experimental, Walkup, or Imaging interface type.

Highlight the prompt or click.

Enter a user login name with a maximum of eight characters beginning with a letter.

Select an Interface type.

Click on the radio button to select the interface type.

Click on the **Save User** button.

Click on **Management** on the menu bar.

Select **Exit** from the drop down menu.

## Setting up Multiple New User Accounts

The new user account will be set up using the default values set in User Account Defaults, see "Setting User Account Defaults," page 58.

Start the *VnmrJ Adm* interface

**Instruction****Window**

Click on **Management** on the menu bar.

Select **Users** from the drop down menu.

Select **Show all VJ Users** from the drop down menu in the Users Panel.

Click on the **New User** drop down menu button and select Multiple Users (current selection or status is highlighted).

Button label changes to **New Users (2 or more)**.

Click on the **New Users (2 or more)**

The **Create 2 or more users** window appears. Enter each user name in the **login names:** field. Separate each user name with a space. Eight characters maximum, alpha first then numeric.

**Instruction****Window**

Click on a **radio button** to assign a user **interface**.

The home directory will be automatically setup (new users - no UNIX account) based upon the user defaults (see “**Setting User Account Defaults**,” page 58) or, if the user was first set up as a UNIX account, the user’s UNIX account home directory is used

Click **Update Users** to create the user accounts

or

click **Cancel** to close the window and not create any accounts.

Optional: Return to create single New User button:

Click on the **Create 2 or more users** drop down menu and select **Single User** (current selection or status is highlighted)

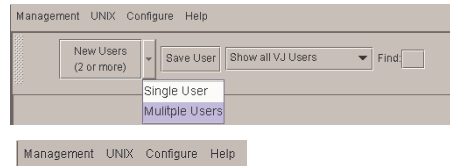

Click on **Management** on the menu bar.

Select **Exit** from the drop down menu.

## Changing the Interface of a User Account

Start the *VnmrJ Adm* interface.

**Instruction****Window**

Click on **Management** on the menu bar.



Select **Users** from the drop down menu.

Select **Show all VJ Users** from the drop down menu in the Users Panel.

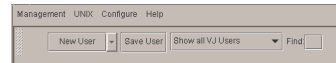

Click on the **user’s** account.

The account’s profile is displayed in the User Profile Panel.

There are five sections to this panel:

- User Login:**
- User Name:**
- Home Directory**
- VnmrJ Operators** (Walkup only)
- Interface Type.**

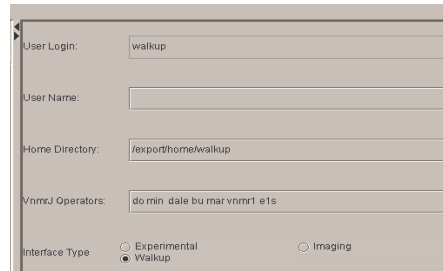

Select an **Interface** type — click on the radio button to select Experimental, Walkup, or Imaging interface type.

Click on the **Save User** button.

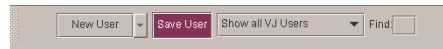

Click on **Management** on the menu bar.

Select **Configure**

Select **Users...**

Select **Update users...**

This will update all global parameters for the new interface.

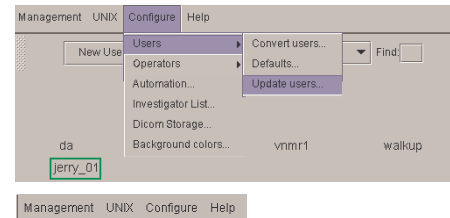

Click on **Management** on the menu bar.

Select **Exit** from the drop down menu.

## Setting Operator Preferences

Start the *VnmrJ Adm* interface

### Instruction

Select **Users** from the drop down menu.

Click **Configure** on the menu bar.

A drop down menu appears.

Select **Operators**

Select **Preferences...**

The **Preferences** window appears.

Enter a default password in the **VnmrJ Operators:** password field for operators that do not have a UNIX login. Operators with a UNIX account login use the UNIX account password to access the walkup operator interface. Operators, both with and without a UNIX account, can change their passwords by selecting Change Password from the Utilities menu on their interface, refer to *VnmrJ Liquids NMR*, *VnmrJ Imaging NMR*, and *Walkup VnmrJ* manuals. Change Password will change the both the Operator and UNIX login password, if a UNIX account exists.

Enter the full path and file name for the icon that appears on the login screen in the **Icon for Login Screen:** field or accept the default Varian Inc. logo.

Click **OK** to accept the preferences

–or–

Click on **Cancel** and make no changes.

The window closes.

Click on **Management** on the menu bar.

Select **Exit** from the drop down menu.

### Window

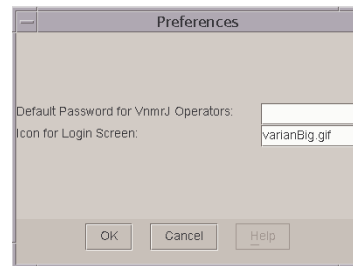
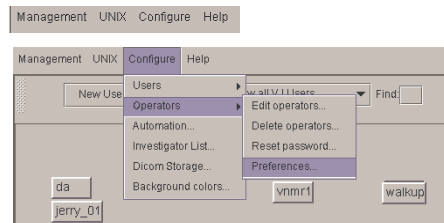

## Adding Operators to a User Account

Start the *VnmrJ Adm* interface

### Instruction

Click on **Management** on the menu bar.

Select **Users** from the drop down menu.

Select **Show all VJ Users** from the drop down menu in the Users Panel.

Click on the **user** account — typically this is the walkup user account.

### Window

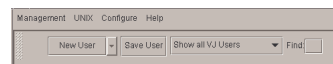

**Instruction**

**Window**

The account's profile is displayed in the User Profile Panel.

There are five sections to this panel:

- User Login:**
- User Name:**
- Home Directory**
- VnmrJ Operators** (Walkup only)
- Interface Type**, for the Walkup Administrator the Walkup button is active.

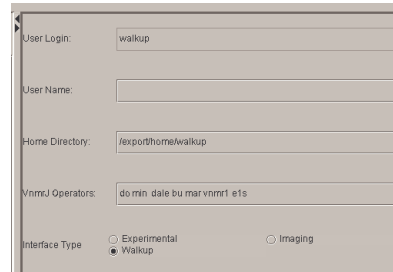

Enter the **name of each operator** that will have NMR privileges in this account. Separate each operator with a space. The operators can have a mixture of VnmrJ only operators and operators with both a UNIX and VnmrJ account.

Operators that do not have a UNIX account are assigned the default password, see [“Setting Operator Preferences,” page 51](#). Operators that have a UNIX account use their UNIX account password to access the VnmrJ operator interface.

Click on the **Save User** button.

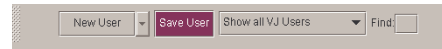

Click **Configure** on the menu bar.

A drop down menu appears.

The drop down menu has the following choices:

- Users**
- Operators**
- Automation...**
- Investigators List...**
- Background colors...**

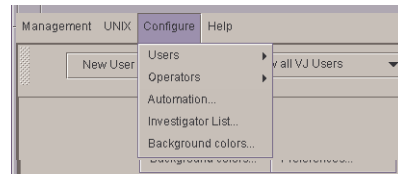

Click on **Operators** on the drop down menu.

A pop out menu appears with the choices:

- Edit operators...**
- Delete operators...**
- Reset password...**
- Preferences...**

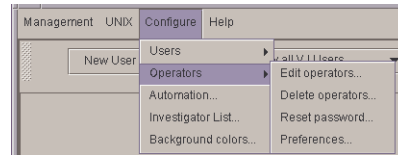

Click on **Edit operators...** and open the Modify Operators window:

**Modify Operators tab.**

All operators are listed.

The Modify Operator tab has three columns:

**Operator** — authorized operator name

**Email** — The E-mail address (optional) for automatic notification when acquisition is completed.

**Panel Level** — refer to [“Setting Panel Levels,” page 57](#) for defaults and level descriptions.

Click on **Management** on the menu bar.

Select **Exit** from the drop down menu.

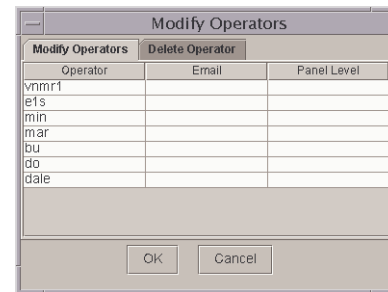

## Resetting Operator Password

This applies to only operators that do not have a operating system (OS) account login. To reset the password for an operator/OS account, refer to the OS installation and administration manual.

Start the *VnmrJ Adm* interface

### Instruction

Click **Configure** on the menu bar.

A drop down menu appears.

Select **Operators**

Select **Reset password...**

The **Reset Operator's Password** window appears.

Enter names of the operators in the VnmrJ Operators: field.

Click **OK** to reset the password for the operators to the default password, see [“Setting Operator Preferences,” page 51](#).

–or–

Click on **Cancel** and make no changes.

The window closes.

Click on **Management** on the menu bar.

Select **Exit** from the drop down menu.

### Window

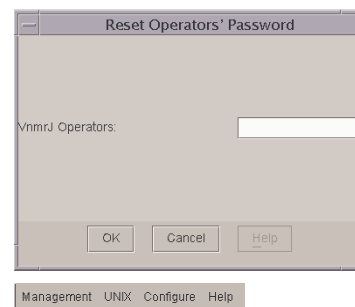
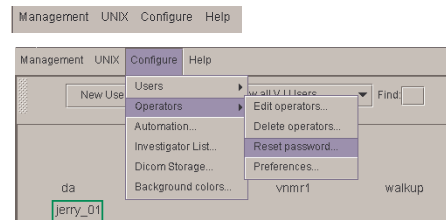

## Deleting Operators from User Accounts

### Deleting Operators from All Assigned Accounts

Start the *VnmrJ Adm* interface

### Instruction

Click **Configure** on the menu bar.

A drop down menu appears.

The drop down menu has the following choices:

**Users**

**Operators**

**Automation...**

**Investigators List...**

**Background colors...**

Click on **Operators** on the drop down menu.

A pop out menu appears with the choices:

**Edit operators...**

**Delete operators...**

**Reset password...**

**Preferences...**

Click on **Edit operators...** and select **Delete operators** :

### Window

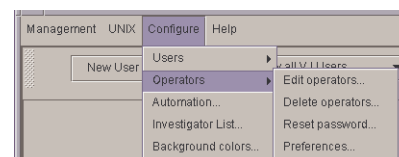
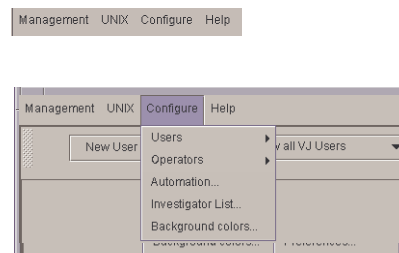

**Instruction**

**Delete Operator tab:**

Click on the operator name or click on multiple operator names to select the operator or operators for deletion. Click a checked operator again to remove the check.

Click **OK** to delete the selected operators from all user accounts the operators have access or click on **Cancel** to close the window and make no changes.

**Window**

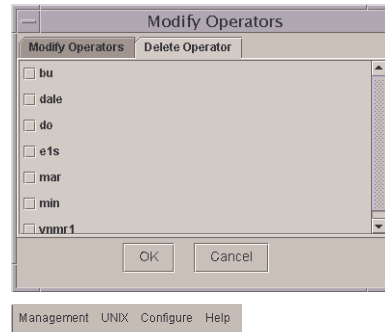

Click on **Management** on the menu bar.

Select **Exit** from the drop down menu.

### Deleting An Operator from a Single Account

Start the *VnmrJ Adm* interface

**Instruction**

Click on **Management** on the menu bar.

Select **Users** from the drop down menu.

Select **Show all VJ Users** from the drop down menu in the Users Panel.

Click on the **user's** account.

Select the one or more operators from the list of operators in the **VnmrJ Operators** field in the User Profile Panel.

Press the delete key.

**Window**

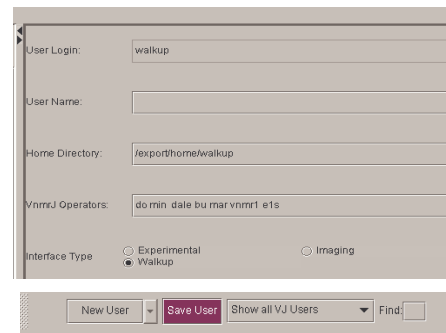

Click on the **Save User** button.

Click on **Management** on the menu bar.

Select **Exit** from the drop down menu.

### Deleting a User Account

Start the *VnmrJ Adm* interface

**Instruction**

Click on **Management** on the menu bar.

Select **Users** from the drop down menu.

Select **Show all VJ Users** from the drop down menu in the Users Panel.

**Window**

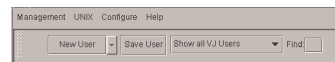

**Instruction**

Right mouse click on the user account name.  
Select **Delete** or drag and drop the user into the trash can.

**Window**

Only the user account is deleted, operators assigned to the account are not deleted. The operators can be assigned to other user accounts, see “[Adding Operators to a User Account](#),” page 51 or deleted, see “[Deleting Operators from User Accounts](#),” page 53.

The home directory and VnmrJ files are not deleted and can be restored from the trash can.

Click on **Management** on the menu bar.



Select **Exit** from the drop down menu.

## Restoring a User Account





Start the *VnmrJ Adm* interface

**Instruction**

Click on the **Trash can** icon.



Click on a User Name and select one of following Trash Can window icons to:

-  delete the user home directory and all related files – cannot be restored.
-  restore the UNIX user account including the home directory and related files.
-  delete all user directories and related files listed in the Trash Can window – cannot be restored.
-  close the Trash Can window.

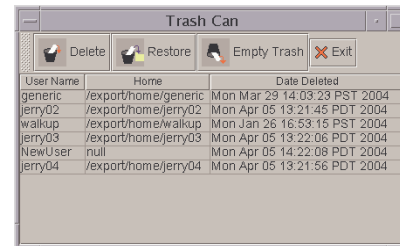

Right mouse click on the user account name.  
Select **Restore**.

Click on **Management** on the menu bar.



Select **Exit** from the drop down menu.

## Converting User Accounts to VnmrJ

Converting the user accounts runs makeuser which updates global parameters and other VnmrJ files.

Start the *VnmrJ Adm* interface

**Instruction**

Click **Configure** on the menu bar.

**Window**

A drop down menu appears.

The drop down menu has the following choices:

- Users**
- Operators**
- Automation...**
- Investigators List...**
- Background colors...**

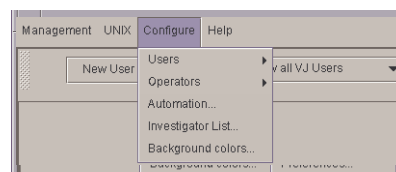

Click on **Users** on the drop down menu.



**Instruction**

**Window**

A pop out menu appears with the choices:

- Convert users...**
- Defaults...**
- Update users...**

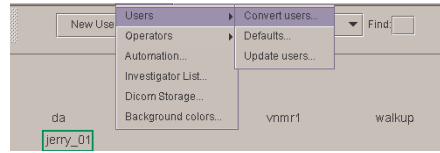

Click on **Users**, select **Convert users...**, the **Change vnmr users to VnmrJ users** window appears.

**Convert User procedure:**

Click a **Select Interface:** radio button to specify the interface type; Experimental, Imaging, or Walkup.

Click on the **user name** in the left side of the window to select the user for conversion (hold the ctrl and shift keys to make multiple selections).  
Click the **right pointing arrow** to add the user.

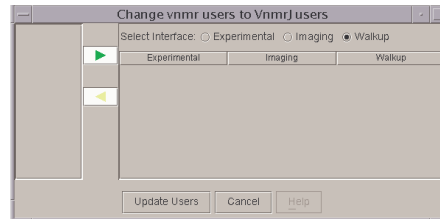

Repeat the *Convert User procedure*: for each user to be converted.

**Remove user from conversion list:**

Click on the **user name** in the right side of the window to select the user for removal from the list for conversion.

Click the **left pointing arrow** to remove the user.

Repeat the *Remove user from conversion list* procedure for each user not to be converted.

Click **Update Users** to convert the selected operators or click on **Cancel** to close the window and make no changes.

Click on **Management** on the menu bar.



Select **Exit** from the drop down menu.

## Updating User Accounts

Updating the user accounts runs makeuser which updates global parameters and other VnmrJ files.

Start the *VnmrJ Adm* interface

**Instruction**

**Window**

Click **Configure** on the menu bar.



A drop down menu appears.

The drop down menu has the following choices:

- Users**
- Operators**
- Automation...**
- Investigators List...**
- Background colors...**

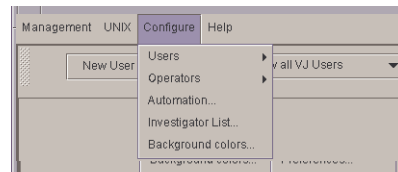

Click on **Users** on the drop down menu.

A pop out menu appears with the choices:

- Convert users...**
- Defaults...**
- Update users...**

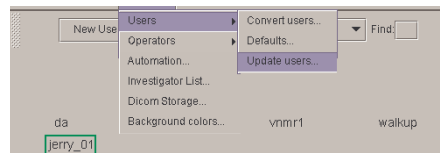

Click on **Users**, select **Update users...**: the **Update VnmrJ Users** window appears.

**Instruction****Window****Update User procedure:**

Click on the **user name** in the left side of the window to select the user for updating (hold the ctrl and shift keys to make multiple selections).  
Click the **right pointing arrow** to add the user to the list for updating.

**Remove user from the update list:**

Click on the **user name** in the right side of the window to select the user for removal from the list for updating (hold the ctrl and shift keys to make multiple selections).

Click the **left pointing arrow** to remove the user.

Click **Update Users** to convert the selected operators or click on **Cancel** to close the window and make no changes.

Click on **Management** on the menu bar.

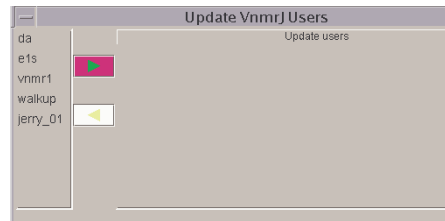

Select **Exit** from the drop down menu.

## Setting Panel Levels

Setting panel levels apply only to walkup account owner and walkup account operators. The default panel level for walkup account owner and operators is 10. All other VnmrJ accounts have a fixed panel level of 100. Start the VnmrJ Adm interface

**Instruction****Window**

Click **Configure** on the menu bar.



A drop down menu appears.

The drop down menu has the following choices:

**Users**

**Operators**

**Automation...**

**Investigator List...**

**Background colors...**

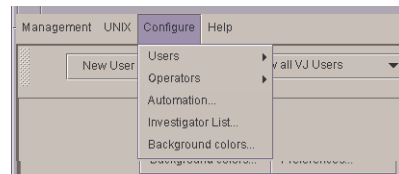

Click on **Operators** on the drop down menu.

A pop out menu appears with the choices:

**Edit operators...**

**Delete operators...**

**Reset password...**

**Preferences...**

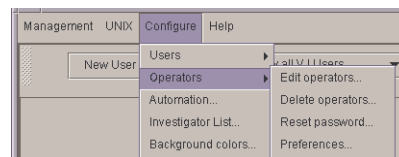

Click on **Edit operators...** and select **Modify Operators** :

**Modify Operators tab.**

The account owner panel level default is 30 and the Operator panel level default is 10. Change the panel level for any operator by entering a value in the Panel Level cell for the operator.

Click **OK** to accept the change, **Cancel** to exit without changing the panel level.

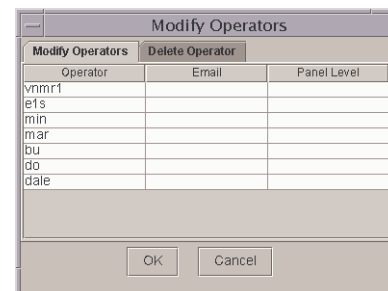

Click on **Management** on the menu bar.

Select **Exit** from the drop down menu.

## Setting User Templates, Directories, and Defaults

### Setting User Account Defaults

Start the *VnmrJ Adm* interface.

#### Instruction

Click on **Configure** on the menu bar.

Select **Users** from the drop down menu.

Select **Defaults...** from the pop out menu

#### Window

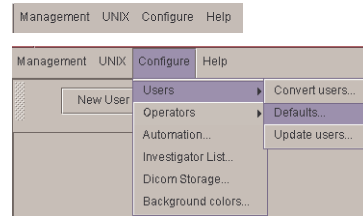

A window opens and shows the defaults that will be used when a new user account is established using vnmrj adm.

Typically, these settings should not be changed. If the standard default must be changed, edit the value in value field next to the name. Enable the value as **Show**, **Private**, or both by placing a check in the box in the value's row.

Click **OK** to exit and save or **Cancel** to exit only.

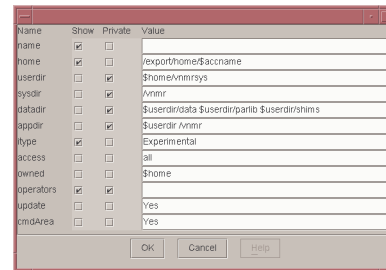

Typically the fields that can be changed are home, and itype. If home needs to be changed then change the name of the home directory for new users as `/space/$accname` or `/export/home/$accname`. `$accname` and other variables starting with `$` should stay as is and the directory names following or preceding them could be changed. For example, to change home from `/export/home/$accname`, just change `/export/home` part to some other directory. e.g. `/space` to create `/space/$accname`.

#### User Default Field

name  
home  
userdir  
sysdir  
datadir  
appdir  
itype  
access  
owned  
update

#### Description

Users full name  
Home directory of user  
Directory with user's private VnmrJ files  
VnmrJ system directory  
Directory path to where data is stored  
Directory path for application-specific files  
Interface type  
Access level to other user's data  
Directories owned by the user  
If enabled– runs makeuser automatically and updates global parameters and other VnmrJ files of existing UNIX accounts

### Setting and Changing User Templates

The default user templates are set up for each user. Additional user templates can added or user templates deleted. These user templates are accessed by the user when saving data in VnmrJ. All the templates for each user are available to them in **Save Data setup** where the user can select any of their templates to use when saving data

Start the *VnmrJ Adm* interface

---

**Instruction**
**Window**

Click on **Management** on the menu bar.



Select **Users** from the drop down menu.

Select **Show all VJ Users** from the drop down menu in the Users Panel.

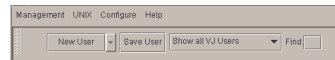

Click on the **user's** account.

Click on **New Label** — adds a blank row below the current user templates.

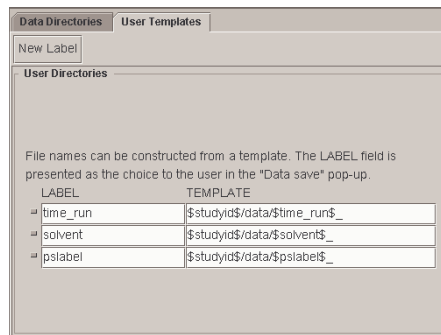

**LABEL** — template name that will appear in the users *Data Save* popup.

**TEMPLATE** — Defines the construction of the file name.

Enter a label name in blank cell in the column under **LABEL**.

Enter a template in the blank cell in the column under **TEMPLATE**.

Remove a label — delete the contents of the cell in the column under **LABEL**.

Remove a template — delete the contents of the cell in the column under **TEMPLATE**.

Click on the **Save User** button.

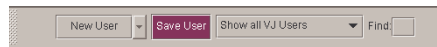

Click on **Management** on the menu bar.



Select **Exit** from the drop down menu.

---

### Setting and Changing User Directories

The default user directories are set up for each user. Additional user directories can be added or user directories deleted. These data directories are available to each user in **Save Data setup** where the user can select any of the data directories to use when saving data.

Start the *VnmrJ Adm* interface

---

**Instruction**
**Window**

Click on **Management** on the menu bar.



Select **Users** from the drop down menu.

Select **Show all VJ Users** from the drop down menu in the Users Panel.

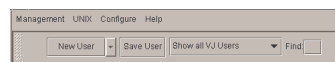

Click on the **user's** account.

**Instruction**

Click on **New Label** — adds a blank row below the current user directories.

**LABEL** — template name that will appear in the users *Data Save* popup.

**Directory** — Defines the construction of the file name.

**Window**

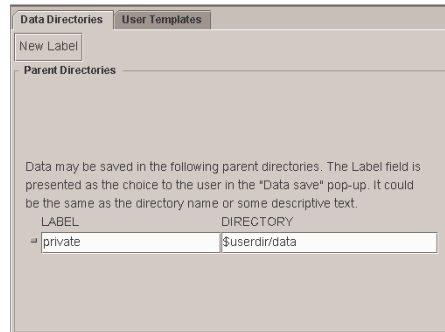

Enter a label name in blank cell in the column under **LABEL**.

Enter a directory in the blank cell in the column under **DIRECTORY** or select the cell and use the file browser, see 5.4 “Viewing the Unix File System,” page 60, select a directory, and click the **Enter Directory** button.

Remove a label — delete the contents of the cell in the column under **LABEL**.

Remove a directory — delete the contents of the cell in the column under **DIRECTORY**.

Click on the **Save User** button.

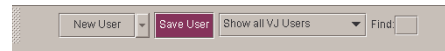

Click on **Management** on the menu bar.



Select **Exit** from the drop down menu.

## 5.4 Viewing the Unix File System

Start the *VnmrJ Adm* interface

**Instruction**

**Select Directory** tab has the following icons:

- Change directory to selected directory.
- Go to admin's /export/home directory.
- Create a new directory in the current directory.
- List files with small icons
- List files with small icons and details

**Window**

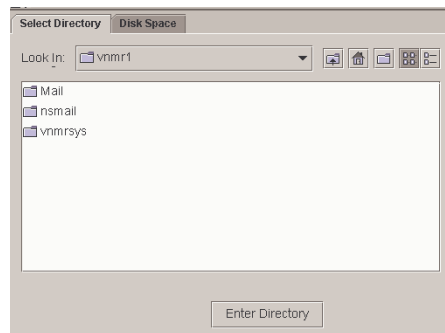

**Enter Directory** button – Select a directory from the file browser and click on Enter Directory. The directory is inserted in the empty directory field of user directories, see “Setting and Changing User Directories,” page 59.

**Disk Space** tab:

Displays information about disk partitions and mounted disk partitions.

| Directory    | Size (kb) | Used (kb) | Available (kb) | Capacity (%) |
|--------------|-----------|-----------|----------------|--------------|
| /            | 2505902   | 1102477   | 1353307        | 45           |
| /proc        | 0         | 0         | 0              | 0            |
| /etc/mnttab  | 0         | 0         | 0              | 0            |
| /dev/td      | 0         | 0         | 0              | 0            |
| /var/run     | 1243808   | 104       | 1243704        | 1            |
| /tmp         | 1250208   | 504       | 1249704        | 1            |
| /export/home | 5722709   | 1481292   | 4184190        | 27           |
| /rd/vnmr     | 7031123   | 6571363   | 389449         | 95           |
| /v_drive     | 25809724  | 15501346  | 10050281       | 61           |
| /s_drive     | 34477097  | 28091463  | 6040864        | 83           |
| /u_drive     | 139820726 | 93808744  | 44613775       | 68           |
| /p_drive     | 10323610  | 10030024  | 190350         | 99           |

## 5.5 Setting Up Investigator List

start the *VnmrJ Adm* interface.

### Instruction

Click **Configure** on the menu bar.

A drop down menu appears.

Select **Investigator List ...**

The investigator list applies to imaging accounts only.

The Investigator List window opens.

Enter one or more investigators in the

**Investigator Names:** with each name separated with a space.

Click the OK button to add the investigator names or click Cancel to exit without adding any investigators to the account

### Window

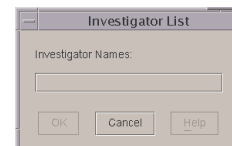
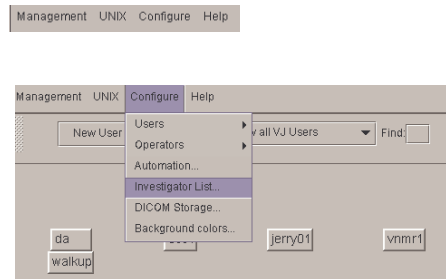

## 5.6 Setting Up Automation Queue

Start the *VnmrJ Adm* interface

### Instruction

Click **Configure** on the menu bar.

A drop down menu appears.

Select **Automation...**

The **Automation Configuration** window opens and has four columns from left to right:

**Day** — Monday through Sunday

**Day-Q Start** — time the day time sample queue starts and the night time sample queue ends.

**Max Length** — Time limit per sample for data acquisition during the daytime acquisition queue for the day of the week in the Day column.

**Night-Q Start** — time the night time sample queue starts and the day time sample queue ends.

**Max Length** — Time limit per sample for data acquisition during the night time acquisition queue for the day of the week in the Day column.

**Times** — in hours : minutes and use a 24 hour clock referenced to the workstation clock.

### Window

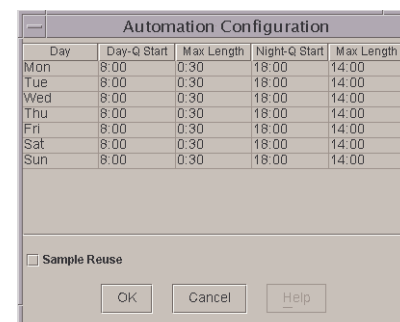
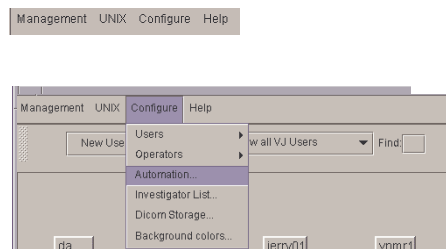

**Instruction****Window**

The DayQ button will be grayed out for samples submitted during the day time queue period that require acquisition times in excess day queue Max Length time. Click on the NightQ button to run the sample during the night queue.

If the Night-Q Start time is the same as the Day-Q Start time or the Night-Q Max Length is set to 0:00, the entire day is a continuation of the previous day's night queue.

**Sample Reuse** — Enable (if box is checked) the re-use of sample numbers during an automation.

## 5.7 Managing Printers and Plotters

### Setting up Printers and Plotters

Start the *VnmrJ Adm* interface

**Instruction****Window**

Click on **Management** on the menu bar.

Management UNIX Configure Help

Select **Printer** from the drop down menu.

The **VNMR: Add Printer/Plotter** window appears

Select **Add Printer** from the **Edit** menu

**Printer name** field, type in the printer name.

Remote printer— the name must be the assigned network name.

Attached directly— any descriptive name up of 14 characters, may include letters, numbers, and underscores but no spaces, dashes, math operators, or special characters.

**Default** — click to set this device as the default printer. One printer should be designated as the default printer.

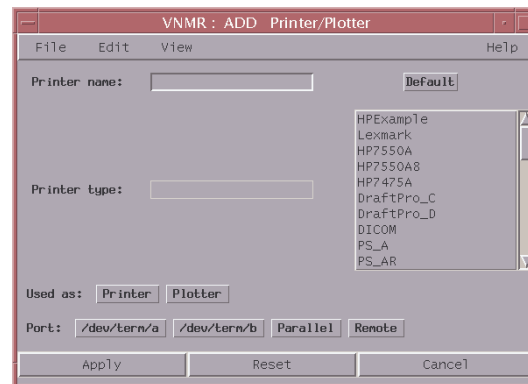

**Printer type**, select a VNMR printer or plotter from the list by double-clicking on your choice from the scrolling list in the window. These types are described in [Table 6](#)

**Used as**, select whether the devices will be used as a **Printer** or **Plotter**.

**Port:**, buttons to select how the device is connected to the Sun computer

**/dev/term/a**

**/dev/term/a**— click to connect device to serial port A

**/dev/term/b**

**/dev/term/b**— click to connect device to serial port B

Select the appropriate baud rate for your device from the list of baud rates below the **Port** selection.



**Parallel**

Click to set this device as a parallel port device

**Remote**

Click to set this device as remote network device. Two more fields appear below the **Port** selections. Enter the name in the **Remote host name** field of the host that is connected to the printer. This host must known to your computer.

Click on the **Remote host OS** button that represents the OS (Solaris or SunOS) running on the remote host. Click **System V** if the remote host is running Solaris, IRIX, or AIX.

**Instruction****Window**

Click **BSD** if the remote host is running SunOS.

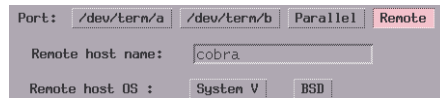

**Apply** —Saves the information and makes the printer or plotter available to VnmrJ.

Repeat this procedure for each additional printer or plotter.

Click **File** and select **Quit** to exit.

Click on **Management** on the menu bar.



Select **Exit** from the drop down menu.

..

**Table 6.** VNMNR Printer and Plotter Types with Descriptions

| <i>VnmrJ<br/>Device Types</i> | <i>Descriptions</i>                                                                                                                                                                         |
|-------------------------------|---------------------------------------------------------------------------------------------------------------------------------------------------------------------------------------------|
| HP7475A                       | HP7475 plotter                                                                                                                                                                              |
| HP7550A                       | HP7550 plotter using 11x17 inch paper                                                                                                                                                       |
| HP7550A8                      | HP7550 plotter using 8 1/2 x 11 inch paper                                                                                                                                                  |
| HPCP1700                      | HP Color Inkjet CP1700 Printer . . .                                                                                                                                                        |
| DeskJet_300                   | HP DeskJet using 300 dpi and a vertical (portrait) orientation in which only the top part of the page can be used for plotting. This value not recommended.                                 |
| DeskJet_300R                  | HP DeskJet using 300 dpi and a horizontal (landscape) orientation in which the entire page can be used for plotting, and a vertical orientation for printing.                               |
| DraftPro_C                    | HP DraftPro plotter using size C paper                                                                                                                                                      |
| DraftPro_D                    | HP DraftPro plotter using size D paper                                                                                                                                                      |
| DraftMaster_A                 | HP DraftMaster plotter using size A paper                                                                                                                                                   |
| DraftMaster_B                 | HP DraftMaster plotter using size B paper                                                                                                                                                   |
| DraftMaster_C                 | HP DraftMaster plotter using size C paper                                                                                                                                                   |
| DraftMaster_D                 | HP DraftMaster plotter using size D paper                                                                                                                                                   |
| DraftMaster_E                 | HP DraftMaster plotter using size E paper                                                                                                                                                   |
| LaserJet_150                  | HP LaserJet (or DeskJet) using 150 dpi and a vertical (portrait) orientation in which only the top part of the page can be used for plotting. This value not recommended.                   |
| LaserJet_150R                 | HP LaserJet (or DeskJet) using 150 dpi and a horizontal (landscape) orientation in which the entire page can be used for plotting, and a vertical orientation for printing.                 |
| LaserJet_300                  | HP LaserJet (or DeskJet) using 300 dpi and a vertical (portrait) orientation in which only the top part of the page can be used for plotting. This value not recommended.                   |
| LaserJet_300R                 | HP LaserJet (or DeskJet) using 300 dpi and a horizontal (landscape) orientation in which the entire page can be used for plotting, and a vertical orientation for printing.                 |
| LJ_B_300R                     | HP LaserJet (or DeskJet) using 300 dpi, B-size paper, and a horizontal (landscape) orientation in which the entire page can be used for plotting, and a vertical orientation for printing.  |
| LJ_A3_300R                    | HP LaserJet (or DeskJet) using 300 dpi, A3-size paper, and a horizontal (landscape) orientation in which the entire page can be used for plotting, and a vertical orientation for printing. |

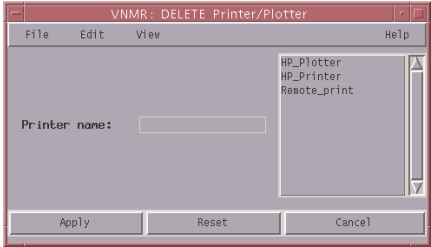



**Table 6.** VNMR Printer and Plotter Types with Descriptions (continued)

| <i>VnmrJ<br/>Device Types</i> | <i>Descriptions</i>                                                                                                                                                                         |
|-------------------------------|---------------------------------------------------------------------------------------------------------------------------------------------------------------------------------------------|
| LJ_A3_300R                    | HP LaserJet (or DeskJet) using 300 dpi, A3-size paper, and a horizontal (landscape) orientation in which the entire page can be used for plotting, and a vertical orientation for printing. |
| LaserJet_4550                 | HP Color LaserJet using 600 dpi.                                                                                                                                                            |
| LaserJet_600R                 | HP LaserJet (or DeskJet) using 600 dpi and a horizontal (landscape) orientation in which the entire page can be used for plotting, and a vertical orientation for printing.                 |
| LJ_B_600R                     | HP LaserJet (or DeskJet) using 600 dpi, B-size paper, and a horizontal (landscape) orientation in which the entire page can be used for plotting, and a vertical orientation for printing.  |
| LJ_A3_600R                    | HP LaserJet (or DeskJet) using 600 dpi, A3-size paper, and a horizontal (landscape) orientation in which the entire page can be used for plotting, and a vertical orientation for printing. |
| PS_A                          | PostScript printer using vertical (portrait) orientation in which only the top part of the page can be used for plotting. This value is not recommended.                                    |
| PS_AR                         | PostScript printer (e.g., PS4069) using horizontal (landscape) orientation in which the entire page can be used for plotting, and a vertical orientation for printing.                      |
| PS4079_HPGL                   | Lexmark PS4079 or PS4079plus using 11x17 inch paper in HPGL mode. HPGL mode is required for color output.                                                                                   |
| QuietJet_96                   | HP QuietJet using low 96 dpi and a vertical (portrait) orientation in which only the top part of the page can be used for plotting. This value not recommended.                             |
| QuietJet_96R                  | HP QuietJet using 96 dpi and a horizontal (landscape) orientation in which the entire page can be used for plotting, and a vertical orientation for printing.                               |
| QuietJet_192                  | HP QuietJet using 192 dpi and a vertical (portrait) orientation in which only the top part of the page can be used for plotting. This value not recommended.                                |
| QuietJet_192R                 | HP QuietJet using 192 dpi and a horizontal (landscape) orientation in which the entire page can be used for plotting, and a vertical orientation for printing.                              |
| ThinkJet_96                   | HP ThinkJet using 96 dpi and a vertical (portrait) orientation in which only the top part of the page can be used for plotting. This value not recommended.                                 |
| ThinkJet_96R                  | HP ThinkJet using 96 dpi and a horizontal (landscape) orientation in which the entire page can be used for plotting, and a vertical orientation for printing.                               |
| ThinkJet_192                  | HP ThinkJet using 192 dpi and a vertical (portrait) orientation in which only the top part of the page can be used for plotting. This value not recommended.                                |
| ThinkJet_192R                 | HP ThinkJet using 192 dpi and a horizontal (landscape) orientation in which the entire page can be used for plotting, and a vertical orientation for printing.                              |
| Zeta                          | Zeta plotter using a single page for output (400 mm maximum plot width)                                                                                                                     |
| Zeta_L                        | Zeta plotter in a “long” orientation with an 800 mm maximum plot width.                                                                                                                     |



## Removing Printers and Plotters

Start the *VnmrJ Adm* interface

| <i>Instruction</i>                                                                                                                                                                                                                                                                                                                                                                                                                                                                                     | <i>Window</i>                                                                      |
|--------------------------------------------------------------------------------------------------------------------------------------------------------------------------------------------------------------------------------------------------------------------------------------------------------------------------------------------------------------------------------------------------------------------------------------------------------------------------------------------------------|------------------------------------------------------------------------------------|
| <p>Click on <b>Management</b> on the menu bar.</p> <p>Select <b>Printer</b> from the drop down menu.</p> <p>The <b>VNMR:DELETE Printer/Plotter</b> window appears</p> <p>Select <b>Delete Printer</b> from the Edit menu</p> <p>Double click on the printer or plotter in the list that you would like to delete.</p> <p>Click on <b>Apply</b> to delete the printer or plotter.</p> <p>Repeat for each printer or plotter to be deleted.</p> <p>Click <b>File</b> and select <b>Quit</b> to exit.</p> |  |
| <p>Click on <b>Management</b> on the menu bar.</p> <p>Select <b>Exit</b> from the drop down menu.</p>                                                                                                                                                                                                                                                                                                                                                                                                  |  |

## Viewing Installed Printers and Plotters

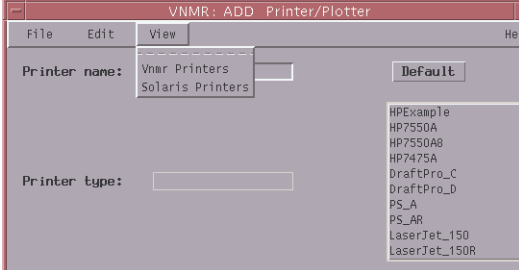
Start the *VnmrJ Adm* interface

| <i>Instruction</i>                                                                                                                                                                                                                                                                                                                                                                                                                                                                     | <i>Window</i>                                                                        |
|----------------------------------------------------------------------------------------------------------------------------------------------------------------------------------------------------------------------------------------------------------------------------------------------------------------------------------------------------------------------------------------------------------------------------------------------------------------------------------------|--------------------------------------------------------------------------------------|
| <p>Click on <b>Management</b> on the menu bar.</p> <p>Select <b>Printer</b> from the drop down menu.</p> <p>The <b>VNMR:ADD Printer/Plotter</b> window appears.</p> <p>Select <b>VNMR Printers</b> from the <b>View</b> menu.</p> <p>Double click the <b>printer</b> or <b>plotter</b> in the list to view details about the device.</p> <p>The <b>VNMR Printers Configuration</b> window opens. The information about the printer is displayed. An example is shown to the right.</p> |  |
|                                                                                                                                                                                                                                                                                                                                                                                                                                                                                        |  |

**Instruction**

**Window**

Select **Solaris Printers** from the **View** menu

Double click the **printer** or **plotter** in the list to view details about the device.

The **Solaris Printers Configuration** window opens. The information about the printer is displayed. An example is shown to the right.

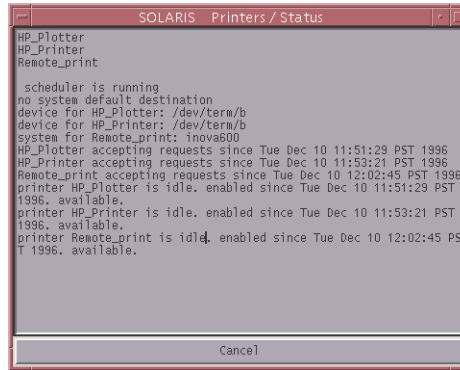

Click **File** and select **Quit** to exit.

Click on **Management** on the menu bar.

Select **Exit** from the drop down menu.



## 5.8 Setting Up DICOM Storage

Start the *VnmrJ Adm* interface

**Instruction**

**Window**

Click on **Configure** on the menu bar.

Select **DICOM Storage...** from the drop down menu.

Enter the values for the following fields:

**HOST** – TCP/IP address of server

**PORT** – Port number in which the dicom storage server is listening

**SERVER TITLE** – Application Entry Title of the storage server

**CLIENT TITLE** – Application Entry Title of the storage client

**BITS** – The size of the image data (8 or 16)

**Close** — Make changes or additions and save.

**Abandon** — Close the window without saving.

Click on **Management** on the menu bar.

Select **Exit** from the drop down menu.

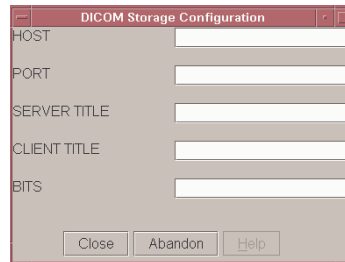

## 5.9 Setting Background Colors

Start the *VnmrJ Adm* interface

**Instruction**

**Window**

Click on **Configure** on the menu bar.

Select **Background colors...** from the drop down menu.



**Instruction****Window****Panel Colors tab:**

All color options are selected from the drop down list to the right of the panel name. Colors can be defined for the following panels:

**Background****User List Panel****Data Directory Panel****User Detail Panel****Disk Space Panel**

Changes only affect the VnmrJ Adm interface.

Click **Close** to accept the changes

Click **Abandon** to close and not accept changes.

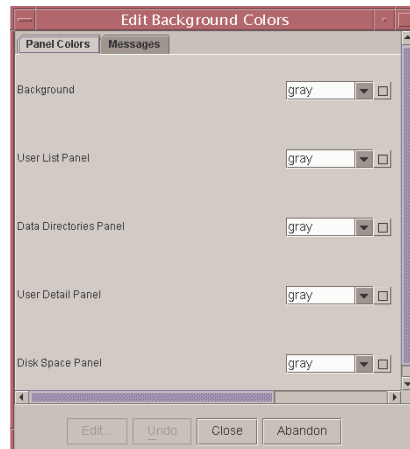
**Message Colors tab:**

All color options are selected from the drop down list to the right of the panel name. Colors can be defined for the following messages:

**On (Active)****Off (Inactive)****Interactive****Ready****Error****Warning****Info**

Changes only affect the VnmrJ Adm interface.

Click **Close** to accept the changes

Click **Abandon** to close and not accept changes

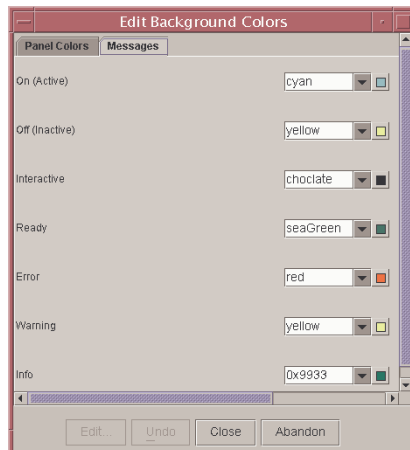

Click on **Management** on the menu bar.

Select **Exit** from the drop down menu.

Management UNIX Configure Help



## Chapter 6. VnmrJ-Accounting Administration

Sections in this chapter:

- 6.1 “VNMR Accounting Tool,” this page
- 6.2 “VNMR Accounting Procedures,” page 71

### 6.1 VNMR Accounting Tool

The VNMR Accounting tool provides NMR administrators with an easy way to keep a log of VNMR users. The program gives you the following capabilities:

- Create groups of console users with single-rate or multi-rate billing.
- Calculate special rates on days identified as holidays on a calendar.
- Show and print lists and accounting reports.

#### Opening the Accounting Tool

The accounting tool window, similar to the one shown in [Figure 10](#), can be opened from either the *VnmrJ Admin* interface or from an OS terminal window.

- Opening from the *VnmrJ Admin* interface:
  1. Click on **Management** in the main menu .
  2. Select **Cost/Time Accounting** .
- Opening from an OS terminal window:
  1. Start an OS terminal
  2. log in as **root**
  3. Enter the command: `/vnmr/bin/vnmr_accounting`

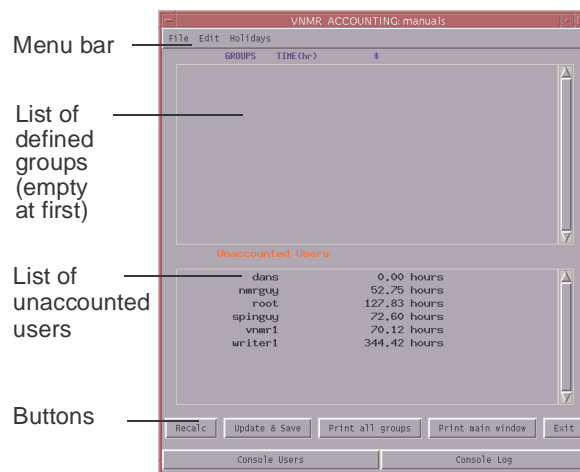

**Figure 10.** VNMR Accounting Window

**Note:** Users other than **root** can look at the accounting tool entries by opening a terminal window and starting the program but they cannot make changes to the data.

## Navigating the VNMR Accounting Tool

The VNMR Accounting tool, shown in [Figure 10](#), consists of:

- “Menu Bar,” next
- “Lists of Groups and Unaccounted Users,” page 70
- “Buttons,” page 70

### Menu Bar

The top of the window has a menu bar with the following options, each of which can be clicked to show a submenu:

|          |                                                                                          |
|----------|------------------------------------------------------------------------------------------|
| File     | For selecting a printer and printing options or for exiting from the accounting program. |
| Edit     | For adding groups and users or for deleting groups and users.                            |
| Holidays | For assigning holidays for billing purposes.                                             |

### Lists of Groups and Unaccounted Users

The middle of the window has two panes listing accounting groups and unaccounted users:

|                   |                                                                                                                                                                                                                                                                                                                                                                                                                                                                                                                                  |
|-------------------|----------------------------------------------------------------------------------------------------------------------------------------------------------------------------------------------------------------------------------------------------------------------------------------------------------------------------------------------------------------------------------------------------------------------------------------------------------------------------------------------------------------------------------|
| Defined Groups    | The upper pane shows a list of accounting groups defined by the program, with the amount of time and the charges for each group. If all users have been added to a group, only this list appears.                                                                                                                                                                                                                                                                                                                                |
| Unaccounted Users | The lower pane lists users who have not been added to a group. The first time you run the accounting program, the accounting window lists only unaccounted users, similar to <a href="#">Figure 10</a> , because no groups have yet been added.<br>The first column identifies the VNMR user.<br>The second column lists the total amount of time, in minutes, that user was logged on to the system. Use of VNMR by unaccounted users is reported as time-only because these users have no cost structure associated with them. |

### Buttons

The bottom of the window has two rows of buttons:

|                   |                                                                                                                                 |
|-------------------|---------------------------------------------------------------------------------------------------------------------------------|
| Recalc            | Recalculates all accounts.                                                                                                      |
| Update & Save     | Saves all accounting information in the directory <code>/var/adm</code> and resets accounting logs.                             |
| Print All Groups  | Prints a summary of charges for each group.                                                                                     |
| Print Main Window | Prints a summary of all charges.                                                                                                |
| Exit              | Exits the accounting program.                                                                                                   |
| Console Users     | Displays a list of console users. Double-clicking on a line in the display opens a detailed window showing the user’s activity. |
| Console Log       | Displays a window of system use, sorted chronologically.                                                                        |

## 6.2 VNMR Accounting Procedures

- “Setting Up Billing Rates,” next
- “Adding Users to Groups,” page 75
- “Calculating Billing Information,” page 73
- “User and Group Information and Lists,” page 74
- “Generating Reports,” page 74
- “Managing Groups and Group Members,” page 75
- “Updating and Saving Records,” page 76
- “Exiting the Accounting Program,” page 76

### Setting Up Billing Rates

- “Multiple-rate Groups,” this page
- “Weekday Rate,” page 72
- “Weekend Rate,” page 72
- “Holiday Rate,” page 73

### Single-rate Users

To set up groups of single-rate users do the following:

1. Click on **Edit** from the main menu and select **Add\_Group**.

2. Type the name of the new accounting group (**Standard** in this example) in the **Group name** field in the window shown in [Figure 11](#).

**Figure 11.** Add Accounting Group Window

3. Click on the **Single rate** button to set a single billing rate for the group Standard.

A window opens similar to [Figure 12](#).

4. Enter the hourly rate in the **Amount per hour** field and click the **Apply** button. The upper pane now lists the group Standard.

**Figure 12.** Add Group Window, Single Rate

5. Repeats steps 2 and 3 to add additional single-rate groups. Each group is listed in the upper pane.
6. Click the **Done** button when all the groups are added.

**Tip:** To simplify accounting for the root user, set up a group named Maintenance with 0 as the charged rate and assign root to this group.



## Multiple-rate Groups

Set up a multiple-rate group as follows for each group:

1. Click on **Edit** in the main menu and select **Add\_Group**.
2. Type the name of the new accounting group (**Special** in this example) in the **Group name** field.
3. Click the **Multi rate** button.

| Days                         | Start time | \$ per hour |
|------------------------------|------------|-------------|
| Su Mo Tu We Th Fr Sa Holiday | 9:00       | 20.00       |
| Su Mo Tu We Th Fr Sa Holiday | 18:00      | 10.00       |
| Su Mo Tu We Th Fr Sa Holiday | 0:00       | 7.00        |

**Figure 13.** Add Group Window, Multi Rate

A window opens similar to [Figure 13](#).

Set the days, times, and rates for the group, for example:

- From 9:00 a.m. to 5:59 p.m. on weekdays, time is billed at \$20.00 per hour.
- Weekday evening time is billed at \$10.00 per hour.
- Weekends (Saturday and Sunday) are billed at \$7.00 per hour.
- Holidays are also billed at \$7.00 per hour.

### Weekday Rate

1. Set up weekday day time:
  - a. Click the **Add line** button once
  - b. Click on **Mo, Tu, We, Th, and Fr** in the top line.
  - c. Enter a time (**9:00** for example) in the **Start time** field
2. Set the weekday day time billing rate (**20.00** for example) in the **\$ per hour** field.
3. Set up the weekday night time:
  - a. Click on **Mo, Tu, We, Th, and Fr** in the next line down.
  - b. Enter a time (**18:00** for example) in the **Start time** field
4. Set the weekday night time billing rate (**10.00** for example) in the **\$ per hour** field.
5. Add as many rates as required by clicking the **Add line** button.
6. Click **Done** when all weekday rates are set.

### Weekend Rate

1. Set up weekend time:
  - a. Click the **Add line** button once.
  - b. Click on **Su** and **Sa** in the new line.
  - c. Enter a time (**0:00** for example) in the **Start time** field
2. Set the weekend time rate (**7.00** for example) in the **\$ per hour** field.

Note that the billing rate begins at the start time and runs until the next start time. Therefore, billing for Sunday night to Monday morning is at \$7.00 per hour until 8:59 a.m. on Monday. Monday night billing (starting at 6:00 p.m. at \$10.00 per hour)

runs through to 8:59 a.m. Tuesday. It is not necessary to start an accounting day at 0:00; the preceding day continues until the first change.

### Holiday Rate

1. Set up holiday time:
  - a. Click the **Add line** button once.
  - b. Click on **Holiday** in the new line.
  - c. Enter a time (**0:00** for example) in the **Start time** field
2. Set the weekend time rate (**7.00** for example) in the **\$ per hour** field.
3. Click the **Apply** button.
4. Set up any additional multiple rate groups by repeating each of the steps in “Multiple-rate Groups,” page 72.
5. Click on the **Done** button when all multiple rate groups are set up.

### Designating Holidays

The multiple-rate group supports a holiday billing rate. Designate the days that are holidays as follows:

1. Click on **Holidays** in the main menu and select **Add**.  
A monthly calendar similar to [Figure 14](#) appears:  
The current day’s date appears as a large, bold number. Use the arrows at the top of the window move the calendar forward and backward. Click the **Today** button and return to the current day’s date.
2. Left mouse button click on each day to designate the day as a holiday. Designated holiday dates change to red. There is no limit to the number of days that can be assign as a holiday.
3. Continue month by month as far ahead as needed.
4. Click the **Save** button and then the **Quit** button when done.



**Figure 14.** Assign Holidays Window

### Calculating Billing Information

1. Click the **Recalc** button.  
Progress is displayed on the main screen. If there are many entries to be processed, this process can be time-consuming.
2. Click on **Recalc** to update billing information —accounts are not automatically updated.

## User and Group Information and Lists

- “Seeing a List of Users and Groups,” next
- “Seeing Detailed User Information,” next
- “Seeing a Chronological User Log,” next

### Seeing a List of Users and Groups

1. Click the **Console Users** button in the accounting window. A window, similar to [Figure 19](#), appears with a list of established groups displayed in the top pane.
2. Double-click the name of the group to see more information about any group listed.

### Seeing Detailed User Information

To see a list of console users and user information do the following:

1. Click the **Console Users** button in the accounting window. A window, similar to [Figure 19](#).
2. Double-click the name of the group to open a window similar to [Figure 15](#).

User information includes login names, the day, month, and year that users were logged in; login and logout times, in hours and minutes; and a

| User    | Day | Month | Year | Time | Duration      | Cost |
|---------|-----|-------|------|------|---------------|------|
| spinguy | Mon | Jul   | 13   | 1998 | 14:15 - 14:36 | 4341 |
| spinguy | Tue | Jun   | 2    | 1998 | 15:01 - 15:02 | 1    |
| spinguy | Tue | Jun   | 2    | 1998 | 11:17 - 11:31 | 14   |
| spinguy | Tue | Jun   | 2    | 1998 | 09:20 - 09:21 | 0    |

Total time used by spinguy is: 4356 minutes, \$ 1002.0 (group Special)

**Figure 15.** Console Users Window for a Selected User

total of the time users were logged on to the console. This information is the most recent data since the last calculation of time and expenditure summaries for the known groups.

### Seeing a Chronological User Log

1. Click the **Console Log** button in the accounting window.
2. A chronological log of console use by each user similar to [Figure 16](#), opens.

| User    | Day | Month | Year | Time | Duration      | Cost |
|---------|-----|-------|------|------|---------------|------|
| root    | Tue | Jun   | 2    | 1998 | 11:32 - 11:34 | 2    |
| writer1 | Tue | Jun   | 2    | 1998 | 15:02 - 08:28 | 1045 |
| root    | Wed | Jun   | 3    | 1998 | 08:28 - 09:03 | 35   |
| root    | Wed | Jun   | 3    | 1998 | 09:05 - 09:09 | 4    |
| vnmr1   | Wed | Jun   | 3    | 1998 | 09:10 - 09:10 | 0    |
| vnmr1   | Wed | Jun   | 3    | 1998 | 09:10 - 09:51 | 40   |
| nmrquy  | Wed | Jun   | 3    | 1998 | 09:52 - 09:53 | 0    |

**Figure 16.** Console Log Window

## Generating Reports

- “Seeing and Printing Reports,” next
- “Selecting A Printer,” next

### Seeing and Printing Reports

1. Click the **Print all groups** button in the accounting window to see and print individual summaries for each group.
2. Click the **Print main window** button to print a summary of individual charges.

## Selecting A Printer

To select a printer for reports do the following:

1. Click on the **File** in the main menu and select **Printer** to open a Printer Selection window similar to [Figure 17](#).
2. Enter the name of a printer known to his system in the **Printer** field. The default is lp.
3. Enters print options (if any) in the **Options** field.
4. Click on **Apply** — printer selection remains current until the program quit.

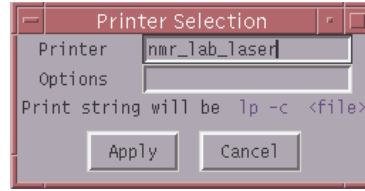

**Figure 17.** Printer Selection Window

## Managing Groups and Group Members

- “Adding Users to Groups,” next
- “Adding Users to an Existing Group,” page 76
- “Deleting a User from a Group,” page 76
- “Deleting a Group,” page 76

## Adding Users to Groups

Add users as either individuals or as members of a group. An easy way to define users as individuals is to create a group with the same name as the user and only assign that single user to the group (e.g., Bob Smith is the only member in the group Bob Smith). After a group is added, its name appears in the upper pane. Add users to the group as follows:

1. Click on **Edit** in the main menu and select **Add\_User**.  
A window, similar to [Figure 18](#), opens.
2. Type **standard** in the **Group name** field.
3. Enter the user name in the **User name** field and click the **Apply** button.
4. Repeat step 3 to add the next user.

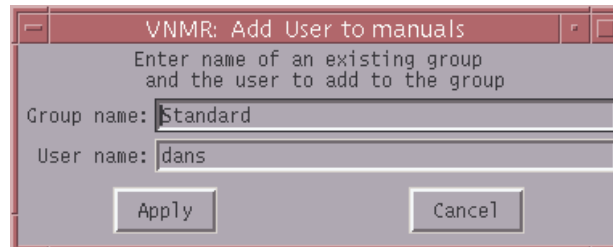

**Figure 18.** Add User Window

Repeats steps 2 and 3 for each group until each user is in a group.

As users are assigned to a group, their names are removed from the Unaccounted Users list. If all users are assigned to a group, no names should appear in the Unaccounted Users pane. Assigning all users is recommended because it makes it easy to identify any unauthorized spectrometer access, because unauthorized users will appear in the Unaccounted User pane.



**Figure 19.** Console Users Window

### *Adding Users to an Existing Group*

To add one or more users to an existing group, do the following:

1. Click on **Edit** in the main menu and select **Add\_User** to open a window similar to [Figure 18](#).
2. Type the name of the accounting group in the **Group name** field.
3. Type the name of the name of a user to add to the group in the **User name** field.  
To enter multiple users, separates each name with a space.
4. Click the **Apply** button to save his changes.

### *Deleting a User from a Group*

To delete a user from an accounting group, do the following:

1. Click on **Edit** in the main menu and select **Delete\_User**.
2. Enter the name of the group from which the user is to be deleted in the **Group name** field.
3. Enter the name of the user to be deleted from the group in the **User name** field.
4. Click the **Apply** button.
5. If the group will be deleted, repeat this process until all the users in the group are removed.

### *Deleting a Group*

To delete an empty accounting group, do the following:

1. Click on **Edit** in the main menu and select **Delete\_Group**.
2. Select the group to be deleted in the **Group name** field.  
Each member of the group must be deleted first before the group can be deleted.
3. Click the **Apply** button.

## **Updating and Saving Records**

Updating and saving records is an administrative option available *only* to `root` users. This feature prevents users other than `root` from editing accounting records. To update and save records do the following:

1. Log in as `root`.
2. Click the **Update & Save** button.  
The information is saved in the `/var/adm` directory as the file `wtmp.mm.dd.yy` and the accounting logs are reset.

## **Exiting the Accounting Program**

Click the **Exit** button OR select **File** from the main menu, then **Quit** to exit the program.

## Chapter 7. System Calibration

Sections in this chapter:

- 7.1 “System Calibration Procedure,” this page
- 7.2 “Calibrating a Probe,” page 78
- 7.3 “AutoCalibration Samples,” page 83
- 7.4 “AutoCalibration,” page 83
- 7.5 “Calibrating - Manual Methods,” page 88
- 7.6 “Shimming,” page 94

This chapter describes the liquids NMR system calibration procedures, including shimming, for a newly installed Varian Inc. NMR spectrometer system. These calibrations and system tests procedures are can be used for routine system calibration maintenance. Procedures described here cover pulse width calibration, decoupler field strength, decoupler 90° pulse width, and decoupler pulse calibration. Additional calibration procedures are described various probe installation and acceptance test procedure manuals, accessory test and installation manuals, and other test manuals.

### 7.1 System Calibration Procedure

These procedure require the following:

- Magnet is installed and ready for normal operation.
- System operating software is installed.
- All required network issues and connections are completed.
- VnmrJ software is installed, printers setup, and hardware configuration set.
- All accessories are installed and ready for calibration.

#### Referenced Manuals

The system calibration procedure here makes reference to the following manuals:

- Probe Installation and Acceptance Test manual(s).
- *Autotest*
- *VnmrJ Liquids NMR User Guide*
- *VnmrJ Walkup*
- Accessory Installation and Operation manuals

#### Procedure

1. Install the primary system probe and complete all the acceptance test procedures. Typically this configuration consists of a conventional probe using 5 mm sample tubes, VT system, and gradient(s) (if present). Sample changers, flow systems and

probes, cryogenic probe and system, and other specialized accessories are installed and calibrated last.

- Refer to “[Shimming](#),” page 94
  - Refer to gradient shimming in the *VnmrJ Liquids NMR User Guide* manual
2. Run Autotest.  
Refer to the *Autotest* manual for instructions and the console acceptance test and installation procedures manual for specifications. This does not apply to Mercury systems, Imaging systems, or Infinity systems.
  3. Calibrate the probe and create a calibration file.  
Choose all the calibration procedures that are appropriate for the probe. A new system or probe installation requires the creation of a system level probe calibration file. Refer to “[Calibrating a Probe](#),” page 78 for instructions – choose the calibration procedures that are compatible with the probe functions.
  4. Install any additional probes - follow the instructions in the Probe Installation and Acceptance Test manual.
  5. Calibrate and create a calibration file for each additional probe.  
Choose all the calibration procedures that are appropriate for the probe. A new system or probe installation requires the creation of a system level probe calibration file. Refer to “[Calibrating a Probe](#),” page 78 for instructions – choose the calibration procedures that are compatible with the probe functions.
  6. Edit the probe calibration file for each probe as necessary and add any manually determined calibrations, e.g. add the N15 calibrations for an HCN probe.  
Refer to “[Editing Probe Calibration Files](#),” page 81.
  7. Calibrate any installed accessories such as:
    - Cold Probe – refer to the *Cold Probe Installation and Cryogenic Systems Installation* manuals
    - Sample Changers – refer to the installation manual
    - LC-NMR and LC-NMR/MS systems – refer to the installation manual
    - VAST – refer to the installation manual

## 7.2 Calibrating a Probe

This procedure uses the VnmrJ Experimental interface.

A complete list of samples and calibration tests are in “[AutoCalibration](#),” page 83.

- “[Logging In and Installing the Probe](#),” page 79
- “[Setting Up the Initial Parameters](#),” page 79
- “[Setting Up the Probe Calibration File](#),” page 79
- “[Tuning Probes](#),” page 80
- “[Starting a Calibration](#),” page 80
- “[Editing Probe Calibration Files](#),” page 81

## Logging In and Installing the Probe

1. Log in to VnmrJ.  
If you are creating a system probe file (typical for initial installation), log in as the VnmrJ administrator (typically this is `vnmr1`) - you must have write permission to `/vnmr/probes/probe_name` to create a system level probe file.
2. Install the probe to be calibrated.  
Probe installation instructions are provided in the *Installation and Operations* manual for the probe.

## Setting Up the Initial Parameters

1. Click on the locator **loop menu**, go to the category **Sort NMR Parameter Files**, and select **Test Files**.
2. Click on the title above the right most column and select **Directory** from the lists that is displayed.
3. Scroll through the files and locate the parameter set **shmd2o**.
4. Click on the parameter set **shmd2o** and drag it to the VnmrJ graphics canvas.
5. The parameter set is now ready for use.

## Setting Up the Probe Calibration File

Before you calibrate a probe for the first time, you must set up the probe calibration file with the `addprobe` command as described below.

1. Click the **Probe** button in the VnmrJ interface or click on the **Utilities** button on the VnmrJ menu bar.
2. Select **Calibration Experiments** or click on the **Probe** button on the hardware bar, see [Figure 20](#).

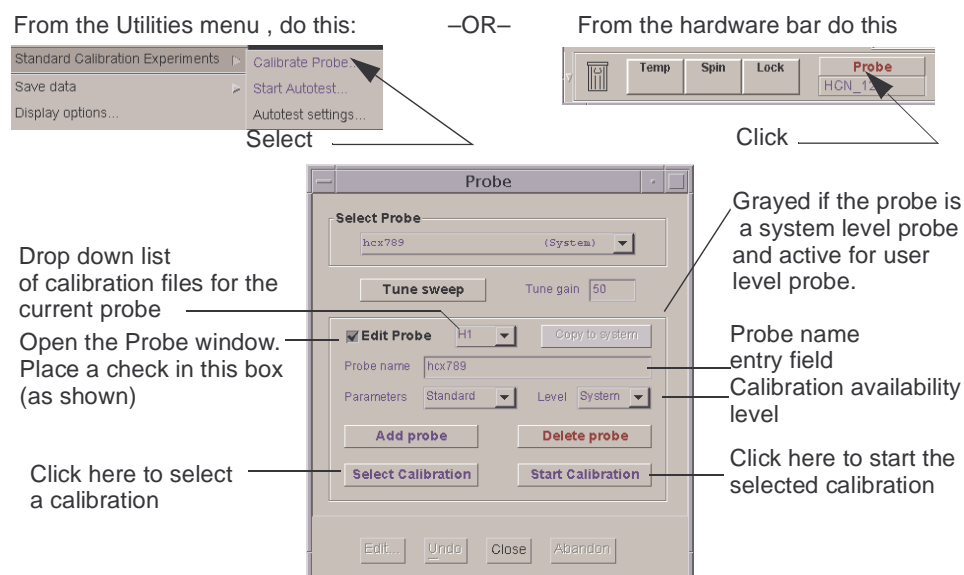

Figure 20. Calibrating a Probe



3. The probe selection window will appear, see [Figure 20](#).
4. Select the probe from the list of probes or create a new probe file.
5. Click the **Edit Probe** box — editing options appear in the Probe window.
6. Do one of the following based upon the operating system login:
  - As VnmrJ system administrator (typically vnmr1) or user with equivalent write permissions. select, from the **Level** drop down menu, either:
    - System** — writes the calibrations into: `/vnmr/probes/probe_name` and makes all calibration available to all users — typical for new system and probe installation.
    - OR –
    - User** — writes the calibrations into: `~/vnmrsys/probes/probe_name` and are available only to the logged in user creating the calibration file.

The User level calibration file can be written to the system level directory, if the user has write permission to the system level directory, by clicking on the **Copy to system** button, see [Figure 20](#).
  - Logged in a user (most users) without write permission to `/vnmr/probes` files
    - Continue with the next step - the Level option is not displayed and all calibrations will automatically be saved to:  
`~/vnmrsys/probes/probe_name`.
7. Do one of the following (refer to [Figure 20](#) as needed):

#### New probe

- a. Type the name of the probe in the **Probe name** field (letters first followed by numbers, e.g. abc456).
- b. Select system or user form the **Level** drop down menu.
- c. Press enter (must press the enter key to add the new probe name).
- d. Click the **Add probe** button.
- e. Continue with “[Starting a Calibration,](#)” page 80.

#### Existing probe

- a. Click on the Select Probes drop down menu.
- b. Select the probe
- c. Continue with “[Starting a Calibration,](#)” page 80.

## Tuning Probes

Probe tuning is covered in the *VnmrJ Liquids NMR* manual. Tuning operations and tuning ranges specific to each probe are covered in the manual provided with the probe.

## Starting a Calibration

Refer to [Figure 20](#) as needed.

1. Click the **Select Calibration** button in the probe calibration popup window.
2. Select a calibration from the calibration popup window:

- a. Click (left mouse) on the **calibration menu** and from the drop down list of calibrations Click (right mouse) on the calibration experiment.
- b. Enter the location of the calibration sample, if a sample changer is not attached to system, enter 0.

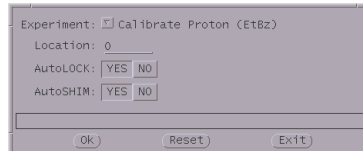

If you are inserting and ejecting the sample from the magnet manually, the insert and eject button is located on the **Lock** page of the **Start** tab.

- c. Select AutoLOCK YES or NO.  
Click the **NO** button if your sample is already locked or if you would prefer to lock manually.
  - d. Select AutoSHIM YES or NO.  
Click the **NO** button if your sample is already shimmed or if you would prefer to shim manually.
3. Follow the procedure in “**AutoCalibration**,” page 83 for the autocalibration procedure that was selected in **step 2a**.
    - You will be asked to verify that the correct sample is present in the probe.
    - Probe calibration will begin.
    - The calibration files will be created and written to the locations determined by the level that was selected in “**Setting Up the Probe Calibration File**,” page 79.

Some probes, like the Autoswitchable and 4 nucleus probes, require additional calibrations not covered in this manual. For information on the calibration of these probes, see the installation, testing, and specifications manual for the probe.

## Editing Probe Calibration Files

### *Calibration Values for N15*

The calibrations for N15 must be added to the probe calibration file following the manual calibration for probes with an X channel that can tune to N15 or probes that have a pre-tuned N15 channel.



1. Click the **Probe** button in the VnmrJ interface or click on the **Utilities** button on the VnmrJ menu bar.
2. Click to check the **Edit Probe** box— editing options appear in the Probe window.
3. Click on the **Select Probes** drop down menu and select the probe.
4. Click on the drop down menu button next to **Edit Probe**.
5. Select **N15** from the list.  
A popup window appears with calibration names and fields to enter values.
6. Add the calibration values in the fields provided – current calibration values are next to the parameter name e.g. pw90 (14).  
If a calibration is not available, leave the field blank – do not enter a zero.
7. Enter a date in the **date field**.
8. Click on **Save**.
9. Click on **Exit**.

### *View or Edit Calibration Values*

Each of the probe calibration files can be viewed and edited. Editing individual parameters is best done at the user level probe file and not at the system level. This is appropriate for specialized calibrations such as high salt concentrations, biological samples, low temperature calibrations etc. that are specific of an individual user but not appropriate for all users.

1. Optional – create a new version of the probe calibration file that will contain any special calibrations (typically a user level requirement):
  - a. Open an terminal window.
  - b. type `cd ~/vnmrsys/probes` – this is the probes directory of the current operating system log in user.  
If this is to be a system level probe file type `cd /vnmr/probes`
  - c. Copy the directory for the probe of interest to a new directory name.
  - d. Change directories to the probe name directory.
  - e. Rename the probe file in the directory to exactly the same name as the directory.
1. Click the **Probe** button in the VnmrJ interface or click on the **Utilities** button on the VnmrJ menu bar.
2. Click to check the **Edit Probe** box— editing options appear in the Probe window.
3. Click on the **Select Probes** drop down menu and select the probe.
4. Click on the drop down menu button next to **Edit Probe**.
5. Select a probe parameter file from the list.  
A popup window appears with calibration names and fields to enter values.
6. Change the calibration values in the fields provided.  
If a calibration is not available, leave the field blank – do not enter a zero.
7. Enter a date in the **date field**.
8. Click on **Save**.
9. Click on **Exit**.
10. Repeat for each probe calibration file as required.
11. Click on **Close** to exit the Probe calibration pop up window.

## 7.3 AutoCalibration Samples

The samples listed in [Table 7](#) can be used for auto calibration. Not all samples are provided with each system. The required samples for the acceptance test procedure during system installation will include one or more of these six samples.

**Table 7.** AutoCalibration Samples

| Sample                                                                                                                                         | Calibrate Option                                     | Part Number  |
|------------------------------------------------------------------------------------------------------------------------------------------------|------------------------------------------------------|--------------|
| 0.1% ethylbenzene in $\text{CDCl}_3$ $^1\text{H}$ sensitivity                                                                                  | Proton                                               | 00-968120-70 |
| 40% dioxane in $\text{C}_6\text{D}_6$ $^{13}\text{C}$ sensitivity                                                                              | Carbon                                               | 00-968120-69 |
| 0.485 M triphenylphosphate in $\text{CDCl}_3$ $^{31}\text{P}$ sensitivity                                                                      | Phosphorus                                           | 00-968120-87 |
| 0.05% trifluorotoluene in benzene- $\text{d}_6$ $^{19}\text{F}$ sensitivity                                                                    | Fluorine                                             | 00-968120-82 |
| 1% $^{13}\text{C}$ -enriched methyl iodide, 1% trimethyl phosphite, and 0.2% Cr(AcAc) in Chloroform-d                                          | Proton, Carbon, ID, and Gradients (organic solvents) | 00-968120-96 |
| 0.1% $^{13}\text{C}$ -enriched methanol with 0.30 mg/ml $\text{GdCl}_3$ in 1% $\text{H}_2\text{O}/99\%$ $\text{D}_2\text{O}$ (AutoTest Sample) | Proton, Carbon, ID, and Gradients (aqueous solvents) | 00-968120-68 |
| 2 Hz $\text{D}_2\text{O}$                                                                                                                      | LOCK, gmap and Z0                                    | 01-901855-01 |

## 7.4 AutoCalibration

The autocalibration experiments are listed in the order they appear in the **Autocalibrate Probe** drop down menu and do not infer an order of operation.

Available auto calibration experiments are:

- “Calibrating Proton,” page 83
- “Calibrating Carbon,” page 84
- “Calibrating Fluorine,” page 85
- “Calibrating Phosphorus,” page 85
- “Calibrating H, C, Ind. Det., and Gradients ( $\text{CH}_3\text{I}$ ),” page 86
- “Calibrating H, Ind. Det., and Gradients (autotest),” page 87
- “Calibrating Z0 and Make LOCK gmap,” page 87

### Calibrating Proton

This section describes how to calibrate proton.

1. Start the calibration, see “Starting a Calibration,” page 80.
2. Eject the sample from the magnet and insert the 0.1% ethylbenzene in  $\text{CDCl}_3$   $^1\text{H}$  sensitivity sample.
3. Tune the probe if needed.
4. Right click the **Experiment** drop-down menu.
5. Select **Calibrate Proton (EtBz)** from the list of calibration options.
6. Click on **Ok**

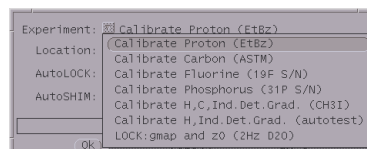

7. Click on **Exit**.
8. Click **Yes** in the popup prompt window if the **correct** sample is in the magnet.
9. Specify a target value for the calibration.  
The value is usually the pulse specification for the probe.

10. Click on **Ok**.

11. Click on **Exit**.

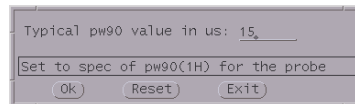

12. The **Solvent** is preset to **CDCl3**.

If a different solvent is used, select the solvent from the drop down menu list on the **Study** page of the **General Tab** in VnmrJ.

13. Click the **Start Calibration** button.

At the end of the calibration routine, the power and pulse width values are automatically incorporated into the probe file.

## Calibrating Carbon

This section describes how to calibrate carbon.

1. Start the calibration, see “[Starting a Calibration](#),” page 80.
2. Eject the sample from the magnet and insert the 40% dioxane in  $C_6D_6$   $^{13}C$  sensitivity sample. Tune the probe if needed.
3. Tune the probe if needed.

4. Right click the **Experiment** drop-down menu and select **Calibrate Carbon (ASTM)**.

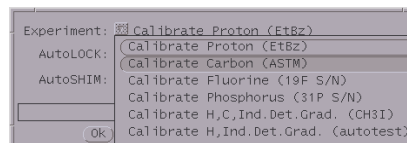

5. Click on **Ok**.

6. Click on **Exit**.

7. Click **Yes** in the popup prompt window if the **correct** sample is in the magnet.

8. Specify a target value for the calibration.

The value is usually the pulse specification for the probe

9. Select a **Relaxation delay**.

Choose **60 (default)** for the undoped signal to noise sample (P/N 00-968120-69) or choose **10 (if doped)** for a doped sample (not supplied).

10. Click on **Ok**.

11. Click on **Exit**.

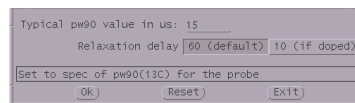

12. The **Solvent** is preset to **Benzene**.

If a different solvent is used, select the solvent from the drop down menu list on the **Study** page of the **General Tab** in VnmrJ.

13. Click the **Start Calibration** button.

At the end of the calibration routine, the power and pulse width values are automatically incorporated into the probe file.

## Calibrating Fluorine

This section describes how to calibrate fluorine.

1. Start the calibration, see “Starting a Calibration,” page 80
2. Eject the sample from the magnet and insert the 0.05% trifluorotoluene in benzene- $d_6$   $^{19}\text{F}$  sensitivity sample.
3. Tune the probe if needed.
4. Right click the **Experiment** drop-down menu and select **Calibrate Fluorine (19F S/N)**.
5. Click on **Ok**.
6. Click on **Exit**.
7. Click **Yes** in the popup prompt window if the **correct** sample is in the magnet.
8. Specify a target value for the calibration. The value is usually the pulse specification for the probe.
9. Click on **Ok**.
10. Click on **Exit**.
11. The **Solvent** is preset to **Benzene**. If a different solvent is used, select the solvent from the drop down menu list on the **Study** page of the **General Tab** in VnmrJ.
12. Click the **Start Calibration button**.

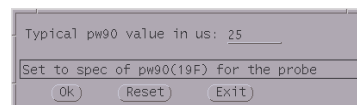
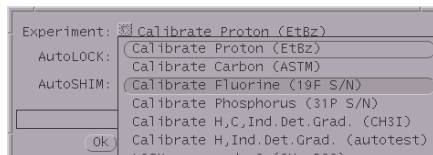

At the end of the calibration routine, the power and pulse width values are automatically incorporated into the probe file.

## Calibrating Phosphorus

This section describes how to calibrate phosphorus

1. Start the calibration, see “Starting a Calibration,” page 80.
2. Eject the sample from the magnet and insert the 0.485 M triphenylphosphate in  $\text{CDCl}_3$   $^{31}\text{P}$  sensitivity sample.
3. Tune the probe if needed.
4. Right click the **Experiment** drop-down menu and select **Calibrate Phosphorus (31P S/N)**.
5. Click on **Ok**.
6. Click on **Exit**.
7. Click **Yes** in the popup prompt window if the **correct** sample is in the magnet.
8. Specify a target value for the calibration. The value is usually the pulse specification for the probe.
9. Click on **Ok**.
10. Click on **Exit**.

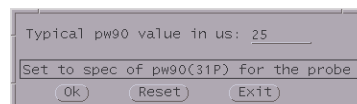
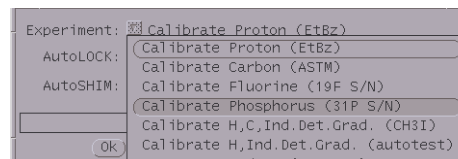

- The **Solvent** is preset to **Benzene**. If a different solvent is used, select the solvent from the drop down menu list on the **Study** page of the **General Tab** in VnmrJ.
- Click the **Start Calibration** button.  
At the end of the calibration routine, the power and pulse width values are automatically incorporated into the probe file.

### Calibrating H, C, Ind. Det., and Gradients (CH<sub>3</sub>I)

This procedure calibrates <sup>1</sup>H and <sup>13</sup>C observe, <sup>1</sup>H and <sup>13</sup>C decouple (pulses as well as  $\gamma$ H<sub>2</sub>), and gradients using the Indirect Detection I sample (C<sup>13</sup> enriched CH<sub>3</sub>I in CDCl<sub>3</sub>). Specific calibration routines can be selected in the customizing menu.

- Start the calibration, see “Starting a Calibration,” page 80.
- Eject the sample from the magnet and insert the 1% <sup>13</sup>C-enriched methyl iodide, 1% trimethyl phosphite, and 0.2% Cr(AcAc) in Chloroform-d sample.
- Tune the probe if needed.
- Right click the **Experiment** drop-down menu and select **Calibrate H, C, Ind.Det.Grad (CH<sub>3</sub>I)** from the list of calibration options.
- Click on **Ok**.
- Click on **Exit**.
- Click **Yes** in the popup prompt window if the **correct** sample is in the magnet.
- Select the **H1 Observe, C13 Decouple, C13 Observe, and H1 Decouple** calibration options (during initial system installation all options must be selected).

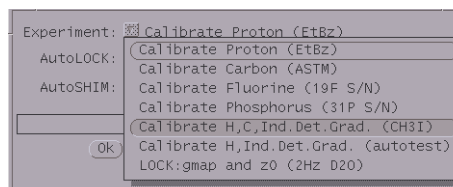

If the probe is equipped with gradients, also select **gradient G/cm/dac** and **C/H gradient ratio** options. These are typical calibration for autoswitchable, indirect detection, and triple resonance probes.

- Specify a target values for **<sup>1</sup>H obs pw90, <sup>13</sup>C obs pw90, <sup>1</sup>H dec pp90, and <sup>13</sup>C dec pwx90** calibrations. The values are usually the pulse specifications for the probe.
- Click on **Ok**.
- Click on **Exit**.

- The **Solvent** is preset to **CDCl<sub>3</sub>**.  
If a different solvent is used, select the solvent from the drop down menu list on the **Study** page of the **General Tab** in VnmrJ.

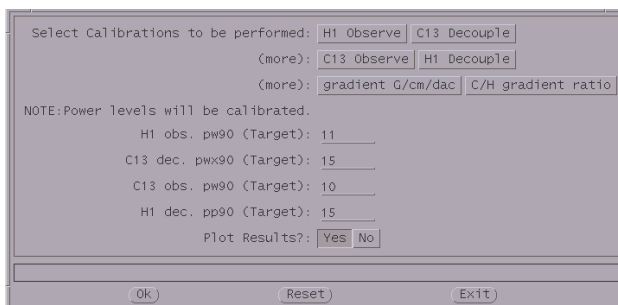

- Select **Yes** (typical choice and required for initial installation) or **No** for plotting the results.
- Click the **Start Calibration** button.  
At the end of the calibration routine, the power and pulse width values are automatically incorporated into the probe file.

## Calibrating H, Ind. Det., and Gradients (autotest)

This procedure calibrates  $^1\text{H}$ ,  $^{13}\text{C}$  decouple (pulse as well as  $\gamma\text{H}_2$ ), and gradients using the AutoTest sample ( $^{13}\text{C}$  enriched  $\text{CH}_3\text{OH}$  in doped  $\text{D}_2\text{O}$ ). You can select specific calibration routines in the customizing menu.

1. Start the calibration, see “Starting a Calibration,” page 80.
2. Eject the sample from the magnet and insert the AutoTest sample.
3. Tune the probe if needed.
4. Right click the **Experiment** drop-down menu and select **Calibrate H, Ind. Det. Grad. (autotest)** from the list of calibration options.

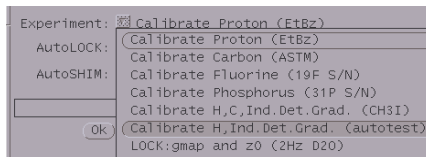

5. Click on **Ok**.
  6. Click on **Exit**.
  7. Click **Yes** in the popup prompt window if the **correct** sample is in the magnet.
  8. Select the **H1 Observe, C13 Decouple, C13 Observe, and H1 Decouple** calibration options.
- If the probe is equipped with gradients, also select **gradient G/cm/dac** and **C/H gradient ratio** options. These are typical calibration for autoswitchable, indirect detection, and triple resonance probes.

9. Specify a target values for  **$^1\text{H}$  obs pw90**, and  **$^{13}\text{C}$  obs pw90**, calibrations. The values are usually the pulse specifications for the probe.

10. Click on **Ok**.
11. Click on **Exit**.

12. The **Solvent** is preset to  **$\text{D}_2\text{O}$** .

If a different solvent is used, select the solvent from the drop down menu list on the **Study** page of the **General Tab** in VnmrJ.

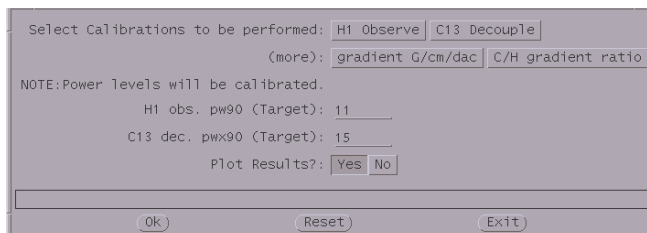

13. Select **Yes** (typical choice) or **No** for plotting the results.
14. Click the **Start Calibration** button.

At the end of the calibration routine, the power and pulse width values are automatically incorporated into the probe file.

## Calibrating Z0 and Make LOCK gmap

This procedure calibrates Z0 and makes a gradient map for gradient shimming for systems with gradients and gradient probes.

1. Start the calibration, see “Starting a Calibration,” page 80.
2. Set **Autoshim** and **Autolock** to **NO**
3. Eject the sample from the magnet and insert the 2-Hz  $\text{D}_2\text{O}$  sample.
4. Tune the probe if needed.



- Right click the **Experiment** drop-down menu and select **Lock:gmap and z0 (2Hz D2O)** from the list of calibration options.

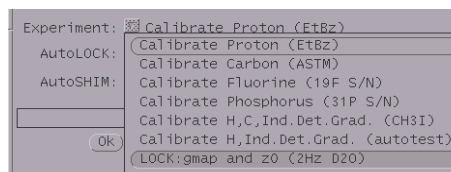

- Click on **Ok**.
- Click on **Exit**.
- The message “**Set z0 exactly on-resonance before starting acquisition**” is displayed on the VnmrJ canvas.  
See *Getting Started* for more information on setting the lock. Open the lock display and set the lock as directed.
- Click **Confirm** in the popup prompt window if **z0 exactly is on-resonance**.
- Click the Start Calibration button.
- Click **Confirm** in the popup prompt window if a **PFG probe** is in the magnet.  
At the end of the calibration routine, the calibrations are automatically incorporated into the probe file.

## 7.5 Calibrating - Manual Methods

The manual calibration are run using command line operations and require the VnmrJ experimental interface. Arrays are general examples and may need to be adjusted for individual probes and systems.

- “Calibrating Pulse Width,” next
- “Calibrating Decoupler Field Strength,” page 89
- “Calibrating Decoupler 90° Pulse Width with Polarization Transfer,” page 90
- “Calibrating <sup>1</sup>H Decoupler Pulse Width with PPCAL,” page 92
- “Calibrating <sup>13</sup>C (or X) Decoupler Pulse Width with PWXCAL,” page 93

### Calibrating Pulse Width

Sample: Any sample;

Parameter set: None.

- Set up parameters to obtain a spectrum on the sample of interest.
- Using either the macro `movetof` or the macro `movesw`, arrange the spectral window so that at least one resonance falls relatively near the center of the spectral window.  
So that you can repeat any experiments using intervals between pulses several times greater than that  $T_1$ , it is helpful to estimate the relaxation time  $T_1$  of the sample.
- Using a pulse that you know (or suspect) to be less than 90°, do one transient (`nt=1`) with no steady-state (`ss=0`) and absolute intensity mode (`ai`).
- Phase that spectrum properly.
- Estimate the 90° pulse width, multiply by 4 to get the 360° pulse width, and enter an array around the 360° pulse width.
- Make sure `d1` is greater than 3 times  $T_1$ , and acquire data using `ga`.

The signals should be negative if the pulse is shorter than  $360^\circ$ , zero if the pulse is  $360^\circ$ , and positive if the pulse is longer than  $360^\circ$ .

7. Select a value of  $\text{pw}$  that gives the result nearest to zero, using rough mental interpolation if none of your results were exactly zero.

Divide this value by 4 to give the  $90^\circ$  pulse width and enter this value in  $\text{pw}90$  as well as in your log book. To be sure you were not off by a factor of two, set  $\text{pw}$  equal to a  $180^\circ$  pulse and obtain a spectrum—the result should be near zero. Now set  $\text{pw}$  to a  $90^\circ$  pulse and the result should be a maximum.

In many cases, the peak is never *exactly* zero but instead shows a “dispersive” signal with some signal positive and some negative. Do *not* readjust the phase in this case. This is normal behavior. Simply select the value of  $\text{pw}$  that gives “equally balanced” up and down resonances.

## Calibrating Decoupler Field Strength

Sample: 60%  $\text{C}_6\text{D}_6$ /40% dioxane (5-mm probe, Part No. 00-968120-69; 10-mm probe, Part No. 00-968123-69; 16-mm probe, Part No. 00-949134-69)  
Parameter set: /vnmr/tests/gamah2

The strength of the *decoupler field*, known as  $\gamma\text{H}_2$ , is important to know for a number of reasons:

- $\text{dmm} = 'f'$  (swept fm or fm-fm modulation) decoupling, the decoupler field strength gives a rough measure of the range over which protons will be efficiently decoupled. Thus at 200 MHz, one might want a 10 ppm or 2 kHz decoupler field.; at 300 MHz, a 3 kHz decoupler field; etc.
- $\text{dmm} = 'w'$  (WALTZ-16) decoupling, protons are efficiently decoupled over roughly twice that range; that is, efficient decoupling over a 2 kHz range can be achieved using only a 1 kHz decoupler field strength.
- For WALTZ-16 decoupling, the decoupler field strength must be known because the modulation frequency parameter  $\text{dmf}$  must be set to equal  $4 \cdot \gamma\text{H}_2$ .
- Various experiments that require the use of decoupler pulses will also require a knowledge of the decoupler field strength.

Decoupler field strength is a function of the decoupler power level (controlled by the parameters  $\text{dpwr}$  or  $\text{dhp/dlp}$ ) and the probe. To a lesser extent, but especially when using highly ionic samples that can “detune” the probe, the decoupler field strength also depends on the sample. For “normal” organic solvents, it is usually sufficient to calibrate the decoupler field strength for each probe at a variety of settings and perhaps to repeat the calibration every few months. For polar solvents, and samples in water at high buffer concentrations, it may become necessary to calibrate the decoupler on the sample of interest, or at least on a comparable sample.

The standard method of calibrating the strength of the decoupler field is off-resonance decoupling. Two experiments are performed, one with the decoupler at a higher frequency than the proper decoupling frequency for a particular proton, and one with the decoupler at a lower frequency.

This technique produces two carbon spectra with “reduced” couplings—multiplets that have basically the same pattern as in a coupled spectrum (doublets, triplets, etc.) but in which the coupling constant is reduced. With these two spectra plus a knowledge of the full coupling constant, an appropriate equation can be used (see K.G.R. Pachler, *J. Magn. Reson.* 7:442 (1972)) to determine the value of  $\gamma\text{H}_2$ . The following procedure is recommended:

1. Insert the standard  $^{13}\text{C}$  sensitivity sample (60%  $\text{C}_6\text{D}_6$  and 40% dioxane).  
The dioxane produces a single resonance, a triplet with 1:2:1 amplitude, when coupled (from the  $\text{CH}_2$  carbon in dioxane). This pattern will change when decoupling is used.
2. Retrieve an appropriate parameter set (assuming that `dpwr` or `dhp` is set correctly) by entering `rtp('/vnmr/tests/gamah2')`
3. Acquire two spectra by entering `ga`
4. Display the first spectrum with two cursors by entering `ds (1)`

5. Position the cursors on the outer lines of the triplet, as shown in [Figure 21](#).
6. Read the value `delta` from the screen.  
Divide the result by 2 (because we really want just the value of a single splitting) and write down that number.

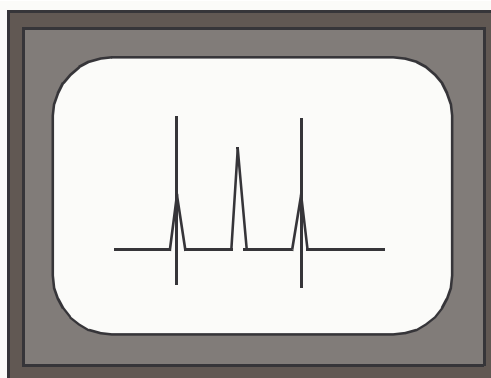

**Figure 21.** Measuring Residual Couplings in Dioxane

7. Display the second spectrum by entering `ds (2)`
8. Position the cursors in a similar fashion, and read the value of `delta`.
9. Write down half that difference.
10. Start the program to calculate the strength of the decoupler field by entering: `h2cal`.

When the system prompts for the low-field residual coupling value, enter the result from step 6.

When the system prompts for the high-field residual coupling, enter the result from step 8.

When the system prompts for the full coupling constant, enter 142, the value for dioxane.

The system displays the calculated value of the decoupler field strength  $\gamma\text{H}_2$ , the predicted coalescence point (the frequency at which single-frequency decoupling would collapse the dioxane to a singlet), and the pulse width for decoupler pulses if this decoupler level is to be used for pulsed decoupling.

## Calibrating Decoupler $90^\circ$ Pulse Width with Polarization Transfer

Sample: 30% menthol in  $\text{CDCl}_3$  (Part No. 00-968120-94)

Parameter set: `/vnmr/stdpar/C13`

The decoupler  $90^\circ$  pulse width value (parameter `pp`) from the test above should be appropriate for polarization transfer experiments. It is also possible to calibrate `pp` separately by using a polarization transfer pulse sequence directly, on the sample of interest. As an example of this procedure, a sample such as menthol having  $\text{CH}$ ,  $\text{CH}_2$  and

CH<sub>3</sub> carbons is useful. If menthol is unavailable, use any small molecule organic compound that is highly soluble.

1. Enter `jexp2 setup('C13','CDCl3') nt=4 ga`.
2. Phase the spectrum and place the two cursors around the aliphatic region.
3. Enter `movesw ga` to narrow the spectral window. Phase the new, narrowed spectrum.
4. Enter `jexp1 setup('H1','CDCl3') nt=4 ga`.
5. Place the cursor in the center of the aliphatic region and enter `sd`. Note the value of `dof` (decoupler offset) after entering `sd`.
6. Enter `jexp2` and set `dof` to the value just found by `sd`.  
As an alternative to this step, set the decoupler offset `dof` to  $-2.5$  times the spectrometer frequency of the system (e.g., on a 200-MHz system, set `dof=-500`; on a 400-MHz, set `dof=-1000`).
7. Enter `dept`. After the help file is displayed, enter an estimate of the decoupler 90° pulse width that was obtained previously, or some other conservative estimate.
8. Enter `mult=0.5 d1=1 ss=2 nt=16 ga`.
9. Phase the data when finished. All resonances should be positive.
10. Enter `pp=10,20,30,40,50,60,70` and rerun the experiment.
11. After the data are transformed, enter `dssh`.
12. Select the value of `pp` that gives the maximum peak heights (use `da` to check the array).
13. Enter a new array of `pp` values, bracketing the value determined in step 12 by  $\pm 20\%$ , using about six smoothly-spaced values. Rerun the experiment and determine the `pp` value for maximum intensity, the same as step 12. This value is a reasonable estimate of the decoupler 90° pulse width.

For spectral editing with the `adept` program or MAGICAL macros such as `cdept`, `hcdept`, or `dept`, you must have a very accurate value of the decoupler 90° pulse width. Obtain this by observing `pp` dependence of CH<sub>3</sub> and CH<sub>2</sub> carbons for `mult=1.0` (CH selection).

1. Enter `mult=1`.
2. Make an array of `pp` in steps of 1  $\mu$ s, from  $-5$  to  $+5$   $\mu$ s around the `pp` value determined above.
3. Enter `ga` and when finished, enter `dssh`.
4. With the CH carbons phased vertically, the CH<sub>2</sub> carbons should go from positive to negative with increasing `pp`. The CH<sub>3</sub> carbons decrease to zero and then increase. The `pp` value corresponding to a decoupler 90° pulse is the value that nulls the CH<sub>2</sub>s. Ideally, the J value used in the parameter set should correspond to that for the type of CH<sub>2</sub> in the molecule: 125 Hz for menthol. If a more accurate value is needed, reset the `pp` range to cover a smaller span and make the steps in `pp` smaller.
5. Update the system log book.

## Calibrating $^1\text{H}$ Decoupler Pulse Width with PPCAL

The PPCAL pulse sequence is used to calibrate the proton decoupler pulse width for experiments such as DEPT, INEPT, and HETCOR. Figure 22 shows the sequence.

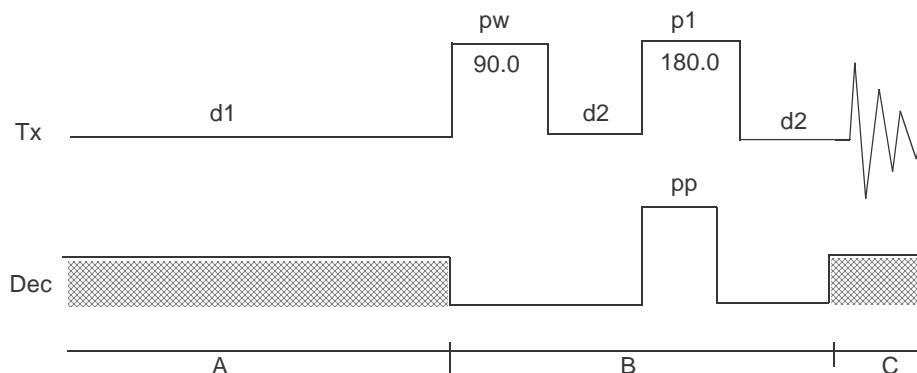

**Figure 22.** PPCAL Pulse Sequence

### Parameters

The `ppcal` macro sets up the parameters for PPCAL as follows:

`pp` is a proton  $90^\circ$  decoupler pulse (in  $\mu\text{s}$ ).

`d2` is a delay that should equal  $1/(2 \cdot J_{\text{CH}})$  (in sec).

`pw` is a  $90^\circ$  pulse on  $^{13}\text{C}$  (in  $\mu\text{s}$ ).

`p1` is a  $180^\circ$  pulse on  $^{13}\text{C}$  (in  $\mu\text{s}$ ).

`dm` is the decoupler mode. The value should be `'yny'`.

`dmm` is the decoupler modulation mode. Its value should be `'wew'` or `'fcf'`.

`pplvl` is the power level for the proton decoupler pulse. `dpwr` is the power level for broadband proton decoupling if the decoupler channel uses a linear amplifier. If the decoupler channel uses a class C amplifier, maximum power is used for the proton decoupler pulse and `dhp` is the power level for broadband proton decoupling.

### Technique

The following technique is recommended:

1. Array parameter `pp`, starting at 0.  
Make sure that delay `d1` is reasonably long compared to the  $^{13}\text{C}$  relaxation times.
2. Phase the first spectrum (`pp=0`). CH and  $\text{CH}_3$  carbons should go from positive to negative, and  $\text{CH}_2$  from positive to zero and again positive.  
All peaks should null when `pp` is a  $90^\circ$  pulse. The CH carbons are the most sensitive.

## Calibrating $^{13}\text{C}$ (or X) Decoupler Pulse Width with PWXCAL

The PWXCAL pulse sequence is used to calibrate the pulse width characteristics of the probe's decoupler channel(s) in indirect detection or triple resonance experiments. PWXCAL can also be used to determine the rf field homogeneity of the decoupler. This calibration is a more sensitive measure of the decoupler X pulse widths than the first increment of HMQC. PWXCAL is designed for dual-broadband systems only and does not support "reverse mode" acquisition.

### Parameters

The `pwxc` macro sets up the parameters for PWXCAL as follows:

`pw` is a proton pulse width (in  $\mu\text{s}$ )

`pw1` is a  $90^\circ$  pulse on X (in  $\mu\text{s}$ ) for the first decoupler.

`pw2` is a  $90^\circ$  pulse on X (in  $\mu\text{s}$ ) for the second decoupler.

`pw3` is a  $90^\circ$  pulse on X (in  $\mu\text{s}$ ) for the third decoupler.

`jC13`, `jN15`, or `jP31` should be set to the appropriate coupling constant.

`name` is set by the `pwxc` macro to indicate which nucleus has been selected.

`dm` is the decoupler modulation and must be 'nnn'.

`dmm` is the decoupler modulation mode and should be 'ccc'.

`dof` is the X-nucleus resonance location (note:  $\text{CH}_3\text{I}$  `dof` is  $-14800$  for a 500-MHz system at 11.4 T).

`dpwr` (or `dpwr2`) is the power level of the "X" decoupler pulse, and `tpwr` is the power level for proton observe if the decoupler channel uses a linear amplifier.

### Technique

The following technique is recommended:

1. Starting from a 1D proton parameter set, type `pwxc` and answer the questions "use decoupler 1, 2, or 3 [1]" and "calibrate  $\text{C}^{13}$ ,  $\text{N}^{15}$ , or  $\text{P}^{31}$  [ $\text{C}^{13}$ ]. Pressing the Return key to either of the questions selects the default response enclosed in square brackets.
2. Array parameter `pw1`, starting at 0, making sure that delay `d1` is reasonably long compared to the  $^1\text{H}$  relaxation times.
3. Phase the first spectrum (`pw1=0`). All peaks null when `pw1` is a  $90^\circ$  pulse.
4. If a second decoupler is present, the parameter `pw2` is arrayed to calibrate the  $90^\circ$  pulse width on that decoupler. If a third decoupler is present, the parameter `pw3` is arrayed to calibrate the  $90^\circ$  pulse width on that decoupler.

## 7.6 Shimming

- “Shim Interactions,” next
- “Gradient Shimming,” page 103

Shims are a set of coils inside the magnet that induce changes in the shape of the magnetic field. Each shim produces a specific change in the magnetic field that can be easily shown. To provide a visual reference for the interactions of the shims, the approximate shapes of the axial gradients (spinning shims) are shown in [Figure 23](#).

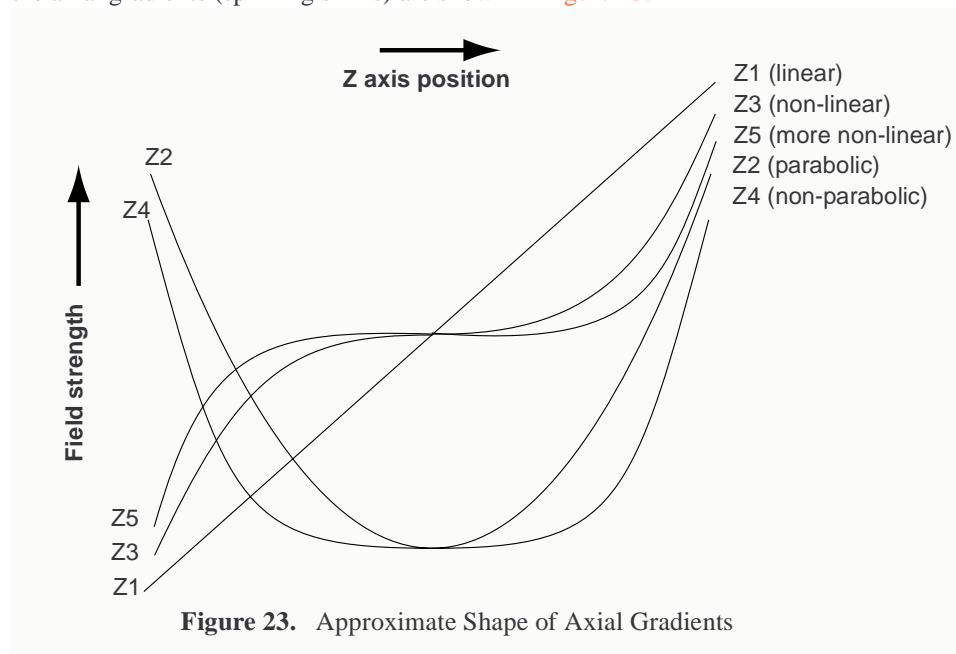

Understanding the effect of various shims on symmetry of the resonance is important in simplifying the shimming process. The following two points must be considered:

- The effect of a given shim on the spectral lineshape.
- How the shims interact with each other.

Understanding how the shims interact is critical to simplifying the task of shimming. Pure shim gradients produce a very specific and predictable effect on the magnetic field and, to a lesser extent, on the resonance lineshape.

### Shim Interactions

The following sections show theoretically predicted changes in lineshape caused by changes in shim DAC values. Shim sets with pure shims, such as the Varian Ultra•nmr shims, follow the theoretically predicted response very closely. Other shim systems, with more interactions between shims, produce somewhat different results.

- “Theoretically Perfect Lineshape and Effect of Z1 Shim,” page 95
- “Effects of Even-Order Shims Z2 and Z4,” page 96
- “Effects of Odd-Order Shims Z3 and Z5,” page 97
- “Effects of Misadjusted Shims,” page 98
- “Effects of Non-Spin Shims,” page 99
- “Summary of Shim Interactions,” page 100

- “Setting Low-Order (Routine) Shims,” page 100
- “Removing Spinning Sidebands (Non-Routine),” page 101
- “Setting the High-Order Axial Shims (Non-Routine),” page 101
- “Setting High-Order Radial Shims (Non-Routine),” page 102

### Theoretically Perfect Lineshape and Effect of Z1 Shim

Figure 24 shows a theoretically perfect line shape (at left) produced in a perfectly homogeneous field (at right). The magnetic field shape appears as a flat line, indicating that the magnetic field does not change across the length of the sample.

Figure 25 shows how changing the linear shim Z1 affects the line shape and the magnetic field.

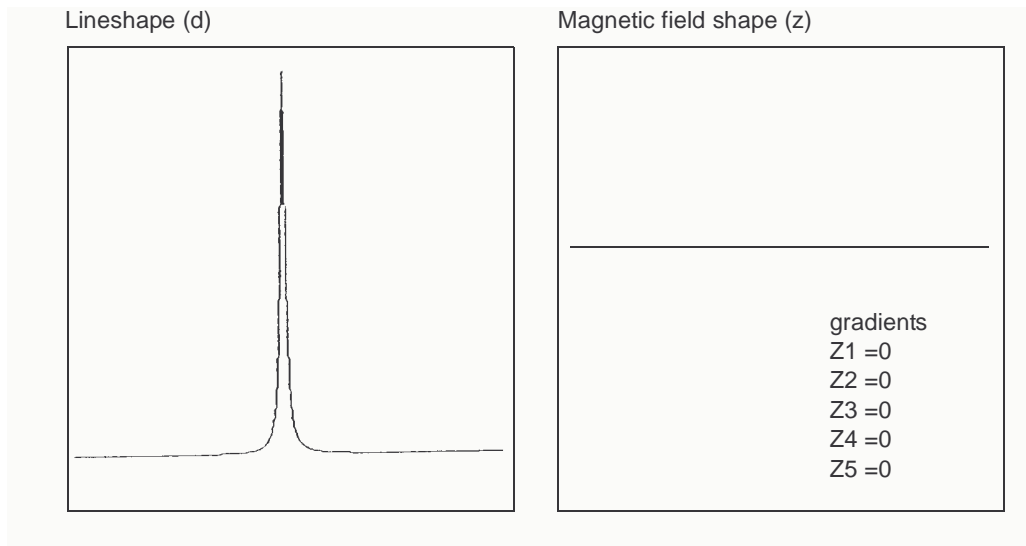

**Figure 24.** Theoretically Perfect Lineshape

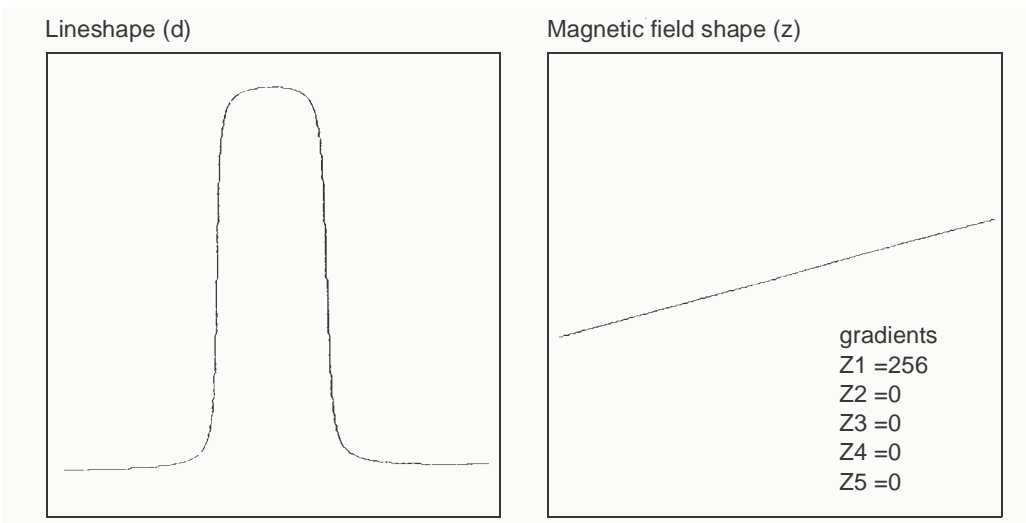
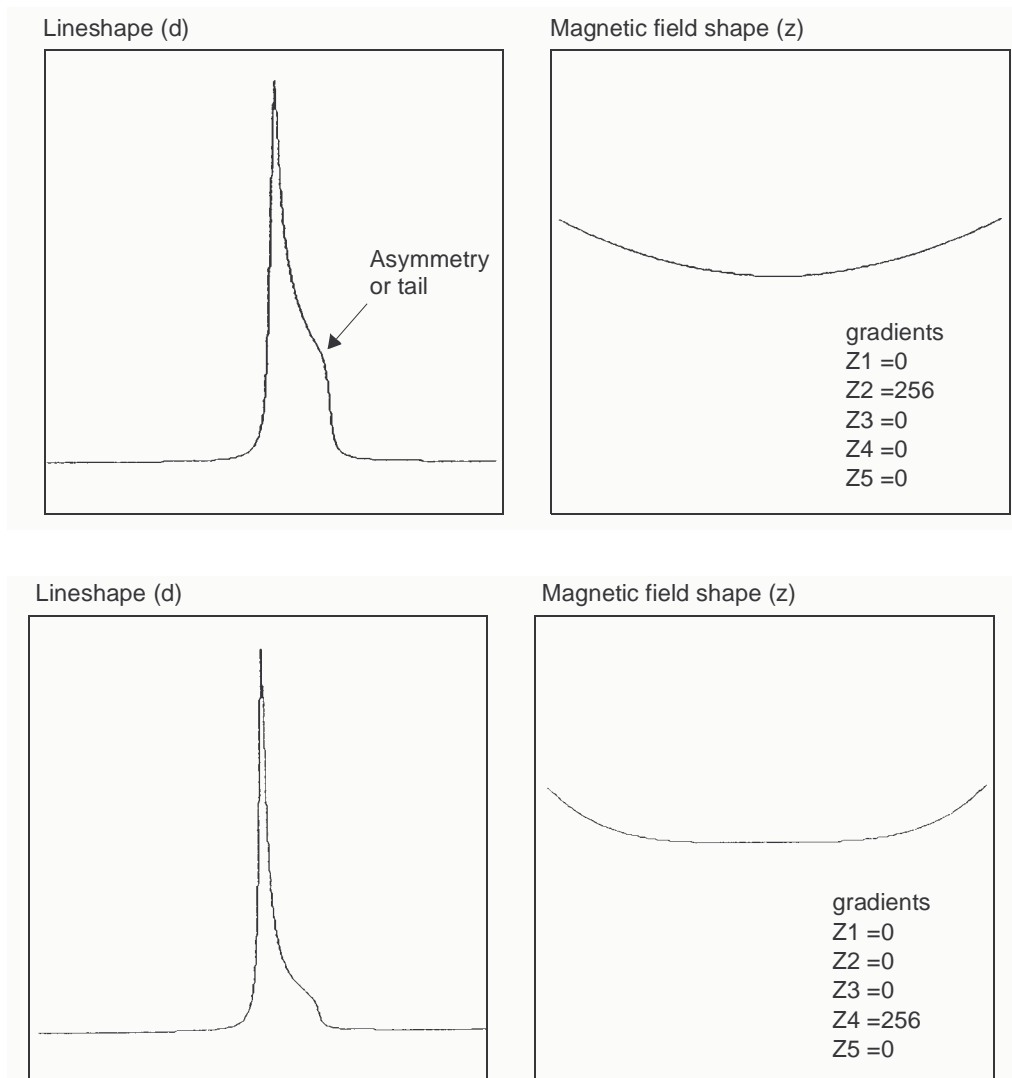

**Figure 25.** Effects of Linear Shim Z1



### Effects of Even-Order Shims Z2 and Z4

Figure 26 shows the effect of the even-order shims, Z2 and Z4, on the line shape. Notice that a positive misadjustment of both shims produces an upfield tail on the peak. If Z2 and Z4 are misadjusted in the negative direction, the asymmetry occurs on the downfield side of the peak. The difference between Z2 and Z4 is in the height of the asymmetry. The Z2 shim causes asymmetry higher on the peak than Z4.



**Figure 26.** Effects of Even Order (Parabolic) Shims Z2 and Z4

### Effects of Odd-Order Shims Z3 and Z5

Figure 27 shows the effects of the odd-order shims Z3 and Z5 on the line shape. The odd-order shims cause broadening of the peak and therefore affect resolution. The Z5 shim is unavailable on systems with 13-channel shim sets (shimset=1).

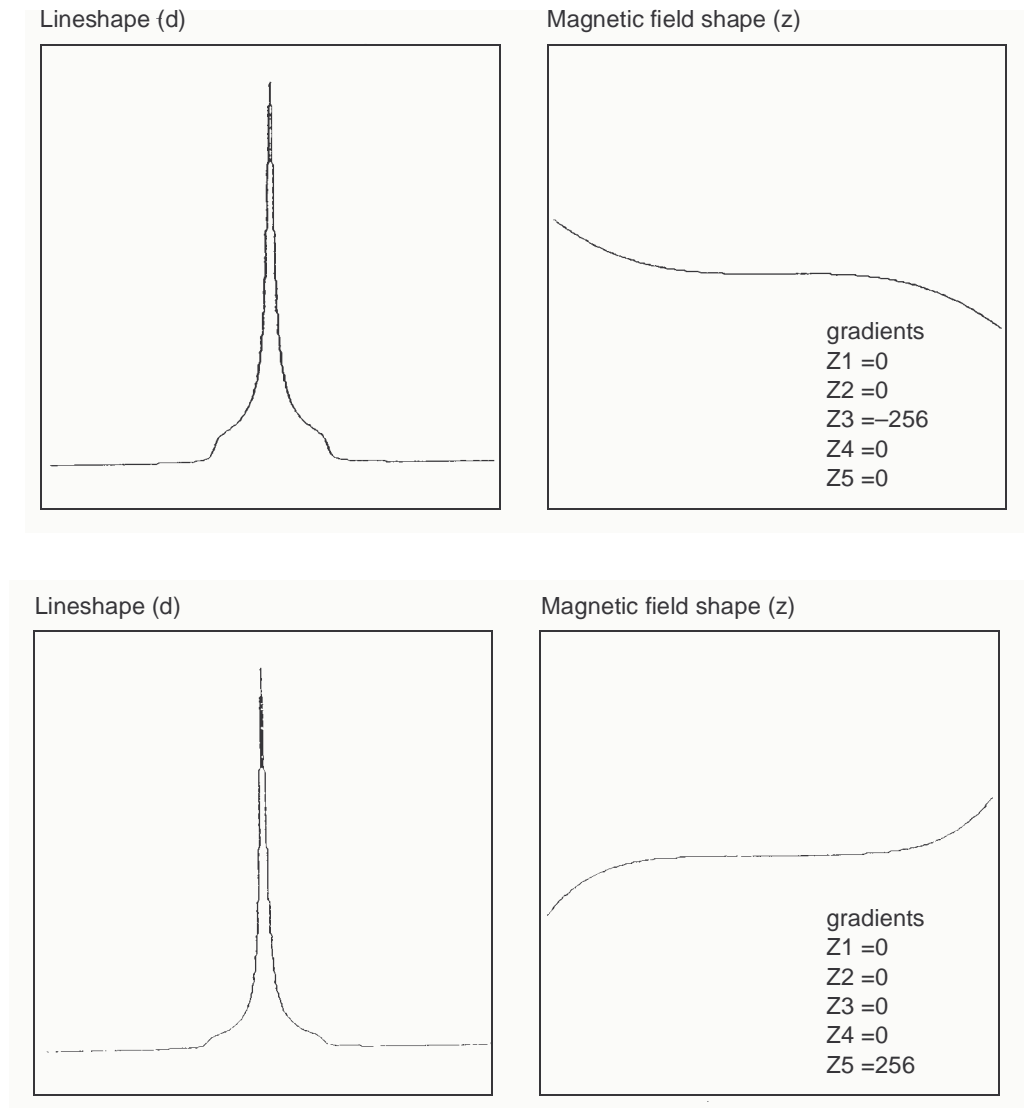

**Figure 27.** Effect of Odd Order (Non-Linear) Shims Z3 and Z5

### Effects of Misadjusted Shims

Figure 28 shows two examples of the effects when more than one shim is misadjusted. This is the typical case with real samples. The complex line shapes make simple visual analysis difficult. A procedure for correcting the shims is provided later in this section that can be used as a guide when adjusting shims.

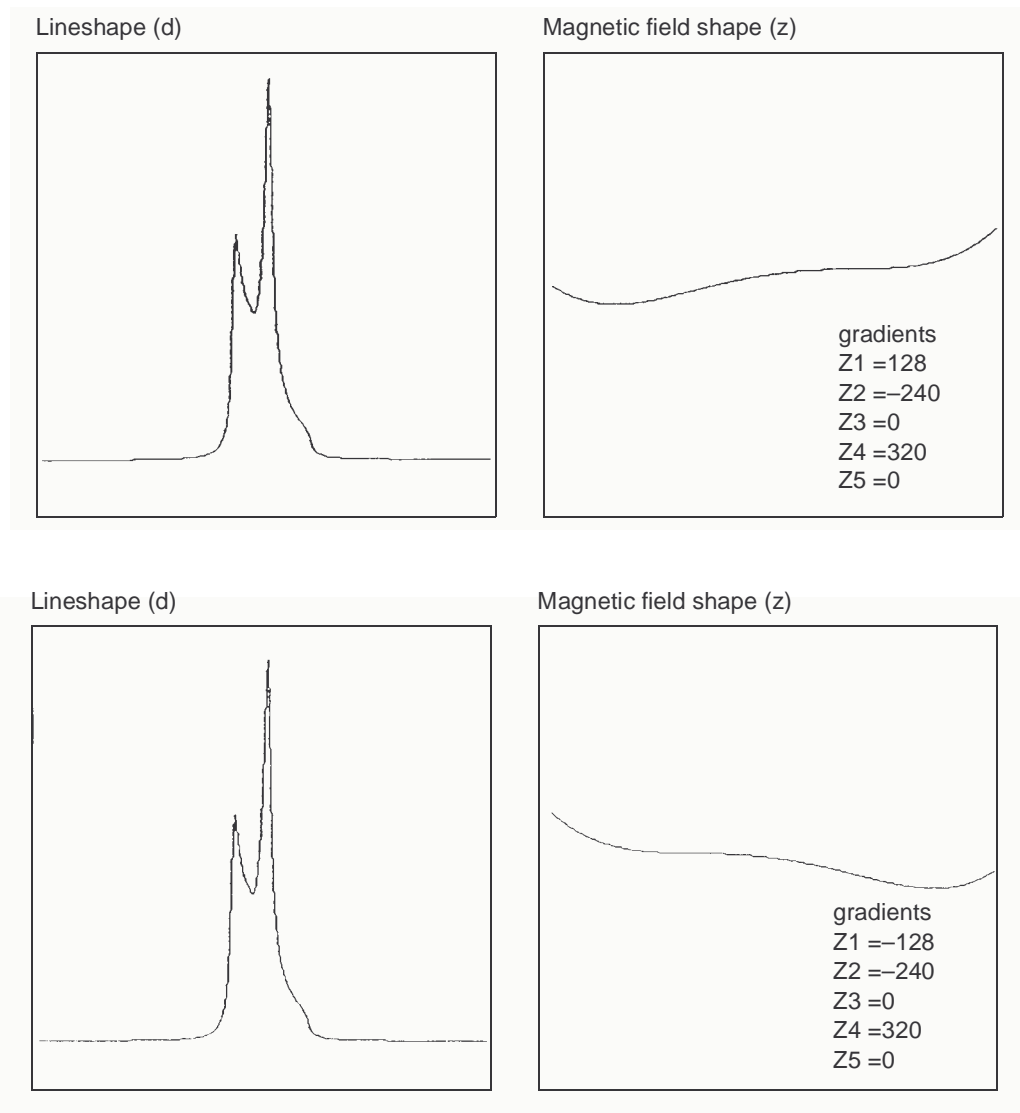

**Figure 28.** Effects of Misadjusted Shims

### Effects of Non-Spin Shims

Figure 29 shows the effect of the non-spin shims on the spectrum (note that Z3X and Z3Y are not available on 13- or 14-channel shim systems). If set wrong, the first-order non-spin shims (X, Y, ZX, and ZY) can cause first-order spinning sidebands. XY and X2–Y2 can cause second-order spinning sidebands. High-order non-spin shims can cause a broad peak base.

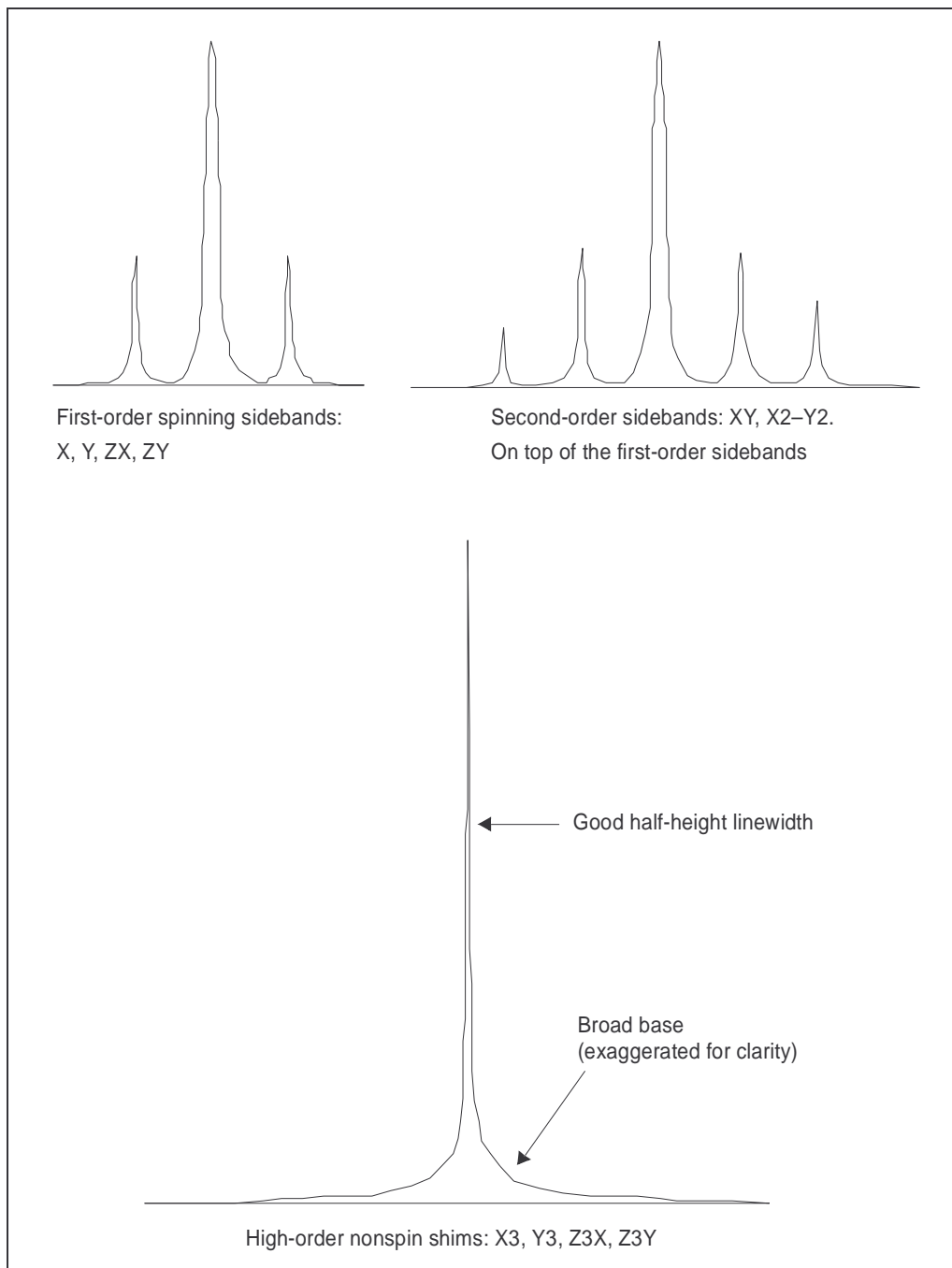

**Figure 29.** Effects of Nonspin Shims

## Summary of Shim Interactions

**Table 8** lists some line shape effects associated with shims. Note that 13-channel shim systems (`shimset=1`) do not have Z5, Z3X, ZXY, etc., and that 14-channel shim systems (`shimset=10`) have Z5 but do not have Z3X, ZXY, etc.

**Table 8.** Lineshape Effects and Their Associated Shims

| <i>Lineshape Effect</i>              | <i>Shims</i>                    |
|--------------------------------------|---------------------------------|
| Split peak                           | Z4 and Z1                       |
| Asymmetry greater than half-way up   | Z2                              |
| Asymmetric foot                      | Z4                              |
| Symmetric feet and or low broad base | Z5                              |
| Symmetrically broad base             | Z3                              |
| Spinning sidebands                   | Low-order radials X1, Y1        |
| Symmetric broad base                 | High-order radials X3, Y3, etc. |

Typical interactions for axial shims:

- Z1 and all other axial shims, to some extent
- Z2 and Z1
- Z3 and Z1
- Z4 and Z2 (with large delta Z4s: Z4 and Z3)
- Z5 and both Z3 and Z1 (Z5 not available on 13-channel shim systems)

## Manual Shimming Using the Lock Level

- [“Setting Low-Order \(Routine\) Shims,” next](#)
- [“Removing Spinning Sidebands \(Non-Routine\),” page 101](#)
- [“Setting the High-Order Axial Shims \(Non-Routine\),” page 101](#)
- [“Setting High-Order Radial Shims \(Non-Routine\),” page 102](#)

### Setting Low-Order (Routine) Shims

The following procedure describes how to set the low-order, or routine, shims. You may need to reset Z0 and lock phase if you are making very large changes in the room temperature shims. With this procedure, you should concentrate on improving the symmetry of the main resonance as well as the half-height resonance and line shape.

1. Click on the **Connect** button in the Acquisition window.
2. Click on the **SHIM** button and set SPIN to on
3. Adjust the lock level to about 80 if possible.  
Maximize lock level with Z1.  
Maximize lock level with Z1 and Z2. Do this by making a change in Z2 followed by maximizing with Z1 again. Continue to iterate in this manner until you can no longer increase the lock level.
4. Acquire the spectrum.  
If the sample is properly shimmed, the lines should be symmetric.

5. If the lines are not symmetric or unusually broad at the base, refer to [Table 8](#) and the previous sections for which shims to adjust. You should not need to adjust Z3, Z4, or the non-spins for most routine samples.
6. If you do need to adjust Z3, do so by interactively shimming Z1 and Z3 in the manner described in step 3 for Z1 and Z2. Changes in Z3 may affect Z2 so after shimming Z3 maximize Z1 and Z2 again.

### *Removing Spinning Sidebands (Non-Routine)*

If the spinning sidebands are not within specification, use this procedure to remove them.

1. Write down the lock level, set SPIN to off, and write down the lock level.
2. Adjust lock to about 80 if possible.
3. Maximize lock level with X.
4. Maximize lock level with Y.
5. Maximize lock level with X and Y.  
Do this by making a change in Y followed by maximizing with X again. Continue to iterate in this manner until you can no longer increase the lock level.
6. Maximize lock level with X and ZX.  
Do this by making a change in ZX followed by maximizing with X again. Continue to iterate in this manner until you can no longer increase the lock level.
7. Maximize lock level with Y and ZY.  
Do this by making a change in ZY followed by maximizing with Y again. Continue to iterate in this manner until you can no longer increase the lock level.
8. Repeat step 4 above.
9. Maximize lock level with XY and ZXY (ZXY not available on 13 or 14 channel shim systems).
10. Repeat step 4, step 5, and step 6.
11. Set SPIN to on and acquire a spectrum.  
If the sample is properly shimmed, the lines should be symmetric.
12. If the lines are not symmetric or unusually broad at the base, refer to [Table 8](#) and the previous sections for which shims to adjust. For most routine samples, you should not need to adjust Z3, Z4, or the non-spins.
13. If you need to adjust Z3, do so by interactively shimming Z1 and Z3 in the manner described in step 3 in the previous procedure (“Setting Low-Order (Routine) Shims”) for Z1 and Z2.  
Changes in Z3 may affect Z2 so after shimming Z3 maximize Z1 and Z2 again.

### *Setting the High-Order Axial Shims (Non-Routine)*

1. If Z4 needs to be adjusted, look at which side of the peak the asymmetry appears—low field to the left and high field to the right.
2. Use [Figure 26](#) to determine which direction to move Z4. If the asymmetry is large (Z4 is far off), change Z4 by a considerable amount to try to push the asymmetry to the other side of the peak. This provides two important pieces of information:
  - Confirms that Z4 is the problem if the asymmetry moves.

- Indicates what the actual value of Z4 should be when Z4 is changed. Since you know the values that caused it to be on either side of the peak, the correct value must be between the two extremes.
3. Set Z4 to the value that produces neither a high-field nor low-field asymmetry. Z4 affects all the shims below it, so repeat the in the “Setting Low-Order (Routine) Shims” procedure.
  4. Maximize the lock level with Z5.
  5. Repeat step 3 and step 4 until no further increase is obtained.

### *Setting High-Order Radial Shims (Non-Routine)*

Note that Z2X, Z2Y, ZX2–ZY2, Z3X, Z3Y, and Z5 are not available on 13-channel shim systems.

1. Set SPIN to off and write down the new lock level.
2. Set the lock level to about 80.
3. Maximize the lock level by shimming Z2X against ZX.
4. Maximize the lock level by shimming Z2Y against ZY.
5. Repeat the “Removing Spinning Sidebands (Non Routine)” procedure.
6. Maximize the lock level by shimming ZXY against XY.
7. Maximize the lock level by shimming ZX2–ZY2 against (X2-Y2).
8. Set SPIN to on and adjust the lock level to 80.
9. Maximize the lock level by shimming Z1, Z2, Z4, and then Z1, Z2, Z3.
10. Repeat step 1.
11. Maximize the lock level by shimming X3 against Y3
12. Maximize the lock level by shimming Z3X against Z3Y if available.  
Refer the Oxford manual for your magnet for approximate Z3X and Z3Y values. Be aware that the signs may be reversed in the Oxford manual, so you will have to experiment to determine the correct sign.
13. Look at the spectrum and decide where to concentrate your effort:
  - For a broad base, adjust Z4 and Z5.
  - For spinning sidebands, adjust the proper order radial shims.

As Z4 and Z5 are optimized, the contribution of Z3 to the breadth of the base becomes more clear, as well as any contribution from the high-order radial shims. Several cycles of shimming are required.

In some cases, local maxima will be encountered, causing the greatest problems. A local maxima may be indicated if a high-order shim continues to increase and eventually reaches the maximum output of the shim supply, without having reached the optimal lock level.

In such a case, carefully reexamine the lower-order shims by making large excursions (systematically), beginning with the lowest-order shim and working up. This is a particularly difficult issue when dealing with the high-order radial shims such as X3, Y3, Z3X, and Z3Y, because their perturbation of the lock level is small relative to the change in the shim current.

At the same time their perturbation of the spectrum is significant in experiments such as water suppression, but their effects can go unnoticed or may not be important in some routine 1D spectra, where large solvent peaks are not encountered.

## **Gradient Shimming**

Gradient shimming is covered in detail in the *VnmrJ Liquids User Guide* manual.





## Chapter 8. Magnet and Spectrometer Maintenance

Sections in this chapter:

- 8.1 “Preventative Maintenance,” this page
- 8.2 “Handling Liquid Helium,” page 106
- 8.3 “Continuing Dewar Service,” page 111
- 8.4 “Troubleshooting,” page 116

### 8.1 Preventative Maintenance

Performing preventative maintenance on a schedule can go a long way toward trouble-free operation of the spectrometer system. If problems do occur, we suggest you review the troubleshooting section in this chapter before calling your Varian service person. The following scheduled preventative maintenance and documentation is suggested.

- “Scheduled Maintenance,” next
- “Maintenance Documentation,” page 106

#### Scheduled Maintenance

A maintenance schedule such as the following is recommended.

##### **Weekly**

1. Check air line traps for dirt or condensed water.
2. Record the following readings (note that the flow rates of nitrogen and helium depends on a variety of factors such as atmospheric pressure and a high reading is not necessarily an indication of a problem, but it is worth investigating):
  - Pressure at the air valve for the magnet.
  - Liquid nitrogen level.
  - Readings on the nitrogen and helium flow meters.

##### **Twice Each Month**

- Check liquid helium level.

##### **Monthly or Bimonthly**

- Check signal-to-noise and lineshape using the standard proton sample, the  $^{13}\text{C}$  90° pulse width, and the decoupler field strength. keep the resulting spectra and parameters in a secure place for future reference.

##### **Periodically**

Back up data to tape using programs such as `dump` and `tar`.

## Maintenance Documentation

It is a good idea to maintain three notebooks to document your system:

- *System Log* – For entering cryogen check and fills, service calls, problems, etc.
- *Operations Log* – For recording what you do every day—what samples were run, what new procedures were tried, what macros were written, what problems were encountered, etc.
- *Procedures Log* –For documenting new procedures, for example, a successful DEPT run (listing all parameters), a standard parameter set for  $^{11}\text{B}$ , the procedure for determining  $90^\circ$  pulse widths, etc.

Each of these notebooks should set aside space for a table of contents on the first page and contain as much detail as possible.

## 8.2 Handling Liquid Helium

Safe and economical use of liquid helium (LHe) requires close attention to details. This section examines the physical properties of helium to show the relationship of these properties to problems in transferring helium.

- “Handling Liquid Helium Safely,” next
- “Measuring Liquid Helium,” page 109
- “Transferring Liquid Helium,” page 109
- “Liquid Helium Service,” page 111
- “Helium Refilling on Oxford 200- and 300-MHz Magnets,” page 114
- “Determining Stinger Lengths for Storage Containers,” page 115

**WARNING:** To prevent possible personal injury, observe all warnings posted on equipment and stated in this manual. Before operating or servicing any part of the system, read the “Safety Precautions” section in the front of this manual.

### Physical Properties of Helium

Table 9 compares the physical properties of helium to nitrogen. When establishing general procedures for handling LHe, consider the special properties of helium described in the following sections.

#### **Low Boiling Point**

Because LHe at atmospheric pressure boils at 4.2 K (kelvin), efficient insulation is required to minimize heat input to the cryogenic fluid (4.2 K is equivalent to  $-269.0^\circ\text{C}$ ). Care must be taken to prevent frozen air plugs from blocking pressure-relief valves and to keep other gases from entering the LHe container. Storage at a pressure slightly above atmospheric is essential to exclude air from storage containers and magnet dewars containing LHe.

#### **Low Latent Heat of Vaporization**

Of all cryogenics, helium has the lowest heat of vaporization, on either a weight or volume basis. On a volume basis, the latent heat of helium is about one-sixtieth the latent heat of

**Table 9.** Physical Properties of Helium and Nitrogen

| <i>Property</i>                           | <i>Helium</i>                | <i>Nitrogen</i>              |
|-------------------------------------------|------------------------------|------------------------------|
| Molecular weight                          | 4.0026                       | 28.01                        |
| Boiling point (1 atm)                     | 4.2 K                        | 77.4 K                       |
| Melting point                             | 1.1 K (25 atm)               | 63.2 K (1 atm)               |
| Critical temperature                      | 5.2 K                        | 126.0 K                      |
| Critical pressure                         | 2.26 atm                     | 33.5 atm                     |
| Density of liquid at boiling point        | 0.125 gm/cm <sup>3</sup>     | 0.807 gm/cm <sup>3</sup>     |
| Density of gas at boiling point           | 0.0176 gm/cm <sup>3</sup>    | 0.00462 gm/cm <sup>3</sup>   |
| Density of gas at 27°C                    | 0.163 kg/m <sup>3</sup>      | 1.138 kg/m <sup>3</sup>      |
| Heat of vaporization                      | 2.58 J/cm <sup>3</sup>       | 161.0 J/cm <sup>3</sup>      |
| $\Delta H=H_{300\text{-H boiling point}}$ | 192.0 J/cm <sup>3</sup> liq. | 186.0 J/cm <sup>3</sup> liq. |

Sources: R. B. Scott, 1959, *Cryogen Engineering*, D. Van Nostrand Co., Inc.  
R. Barron, 1966, *Cryogenic Systems*, McGraw Hill Book Co.  
A Wexler, 1951, *Journal of Applied Physics*, 22:1463.

nitrogen and one-half the latent heat of liquid hydrogen. Therefore, the slightest heat input from any source (pressurizing gas or poor insulation) causes loss of LHe.

### **High Specific Heat of Vapor**

To vaporize one liter of LHe requires 2580 joules. The same heat input will raise the temperature of the resultant vapor less than 4 K. To heat the vapor to room temperature requires  $1.9 \times 10^5$  joules. Liquid losses can be substantially reduced, including losses from initial system cooldown, by using this vaporization property. Disregard of the property can lead to high losses during operations, such as topping-off a partially filled container.

### **Low Liquid Density**

The density of LHe, 125 grams per liter, is about one-sixth the density of liquid nitrogen (LN). Because of the low density, the LHe content of a nitrogen-shielded container is difficult to gauge by weight.

### **High Vapor Density**

Although helium is a very light gas at normal pressure and temperature, its vapor density at the normal boiling point is higher than that of any of the atmospheric gases. Helium vapor expands greatly upon warming to ambient temperatures, and if confined to a fixed volume, the pressure increase is correspondingly large. As a result, “empty” containers, filled only with very cold vapor, must be treated the same as containers containing liquid. Adequate venting must be maintained, and precautions must be taken to prevent formation of frozen air plugs in the container neck tubes.

### **Small Difference Between Vapor and Liquid Densities**

The small difference between the densities of LHe and cold helium vapor may lead to high entrainment losses under flow or boiling conditions.

## Handling Liquid Helium Safely

**WARNING:** The extremely low temperature of liquefied helium and nitrogen can cause skin damage similar to high-temperature burns. Contact with the cold gas evolving from the liquid may produce the same effect. Delicate body tissues, such as the eyes, are easily damaged by exposure to cold gas or liquid. Skin can stick to metal that is refrigerated by liquid helium and can tear when pulled away. Immediately flood with large quantities of unheated water any area of the body that is “burned” by liquid or cold gas, and then apply cold compresses. If the skin is blistered or there is any chance the eyes are affected, immediately seek medical treatment.

Before any transfer of LHe is attempted, know the safety precautions and operating instructions for the hardware used, especially the following:

- Avoid contact of gaseous helium with any part of the body. Wear safety coverings, including a complete face mask and thermo-insulated gloves. The gloves should be clean and dry, and should be loose-fitting so that you can throw them off quickly if frozen by contact with the gas.
- Handle and store helium containers in adequately ventilated areas. Helium and nitrogen gases are not toxic or flammable. However, gas evolving from the liquid in an enclosed space can reduce the oxygen content of the surrounding air and cause a potential asphyxiation hazard. Because nitrogen and helium gases are odorless, colorless, and tasteless, their presence is undetectable by the human senses.
- Be sure pressure-relief valves are adequately sized. LHe vaporizes rapidly when heat is introduced. Therefore, the pressure-relief valve for LHe containers and equipment must have sufficient capacity to safely release the rapidly expanding helium gas.
- Prevent pressure-relief valves from freezing open. An open valve allows the container to blow down, and eventually air backflows into the container and freezes.
- Neck tubes may still be unobstructed even if pressure inside the helium container is above atmospheric. Check containers when received and periodically recheck each container to be sure the vents are unobstructed.
- Very cold helium gas vents upon removal of the top fitting of a container. Cap or seal the container rapidly because the top fillings and valves will become cold and frosted, making sealing more difficult.

Most LHe storage containers are designed with an inner assembly within the vacuum jacket. Because the innermost neck is made of a thin material, the container is vulnerable to rough handling, and especially to a sudden shock. Take the following precautions to prevent damaging containers:

- Never try to pour liquid out of the container; use a vacuum-insulated transfer tube.
- Keep the container vertical at all times.
- Never roll, tip or slide the container. Use a dolly when moving it.
- Do not drop the container.
- When transporting the container, fasten it securely to prevent it from moving or falling over.

## Measuring Liquid Helium

The thermal acoustical liquid level indicator, or flutter tube, is used to locate the surface of LHe inside a container. The device depends upon the thermal-acoustic oscillations generated in tubes that have one end at room temperature and the other at LHe temperature.

The flutter tube consists of a length of 1/8 in. thin-wall stainless steel tubing with a small cup, or funnel, shape at the warm end, flared to a diameter of about 1/2 in. When the tubing end is inserted into a dewar of LHe, acoustical oscillations occur that abruptly change in intensity and frequency as the end of the tube passes through the liquid zone into the dense gas zone.

### Using the Flutter Tube

Take the following steps to measure LHe with a flutter tube:

1. Slowly insert the tube into the LHe container until the tube touches bottom, then place an alligator clamp on the tube, level with the top of the container.
2. While slowly raising the tube, observe vibrations by closing off the top end of the tube with your thumb. When the end of the probe passes from the liquid zone to the dense gas zone, the vibrations intensify and the frequency changes. Place another clamp on the tube, level with the top of the container.
3. Measure the distance between centers of the two clamps; this is the LHe depth.

### Air and Moisture Ice Hazard

A hazard is created when air and moisture are pulled into the nitrogen shield and the inner chamber of LHe containers. Sudden barometric pressure changes can cause the air diffusion to increase. Once into the LHe neck tube, the heavier gases in the air diffuse to the bottom and condense, and then solidify near the LHe end of the tubes. The moisture in the air also forms ice in the LN tubes. The plugs formed by the ice can cause damage to equipment.

**CAUTION:** Air and moisture condensation can result in a solid ice plug in the LHe chamber pressure vents. This obstruction can result in damaged equipment. Keep all vents capped or sealed when possible.

## Transferring Liquid Helium

The following sections summarize transferring LHe from a storage container to the LHe chamber in a superconducting magnet. The actual procedure used to transfer LHe when installing and maintaining Varian NMR superconducting magnets is given later in this chapter.

### Helium Movement through the Transfer Line

When a cryogenic liquid is started through a typical transfer line that is initially at room temperature, the liquid at first is quickly evaporated and nearly the entire line contains only gas. As more liquid enters, part of the cryogenic source end of the line becomes cooled below the saturation temperature, and this part contains a pure liquid phase. Toward the destination end of the transfer line is a region in which both liquid and vapor are present. In the remainder of the transfer line, only gas is flowing. A very light gas plume appears at the exit end of the tube.

As the line is further cooled by the evaporating liquid and by the resulting cold vapor, the liquid phase travels farther along the line until finally liquid approaches the exit end. The vaporized liquid appears as a very dense white fog blown out from the end of the tube.

If the warm vapor that precedes the liquid is discharged into the LHe chamber of the magnet, it evaporates some of the liquid already present. This evaporation can be largely avoided by making sure the transfer tube is precooled before inserting it into the equipment, which already contains LHe.

If the warm line is permitted to deliver excessive warm gaseous helium to the LHe chamber of the magnet, a serious evaporation of liquid can result. The turbulence caused by the discharge of warm (nonliquid) helium can result in a quench of the magnet field present.

### **Preparations for Transfer**

The transfer tube must have a good vacuum (50 microns warm, maximum pressure). The appearance of condensed moisture or frost on the tube during transfer shows that the vacuum is poor, reducing the insulation properties created by the vacuum and possibly preventing the transfer. A small spot of frost indicates a thermal “short” caused by contact of metal surfaces. Stop the transfer immediately because LHe is vaporizing in the tube, due to the heat conducted through this thermal short.

Make sure that the vacuum-jacketed portion of the transfer tube extends below the bottom of the neck tubes on the supply and receiving containers.

### **Typical Transfer Procedure**

1. Verify the amount of LHe needed and make sure that amount is available for transfer.
2. Set or verify that helium gas pressure is 4 to 5 psig.
3. Precool the transfer tube, as follows:
  - a. Vent the storage dewar.
  - b. Insert the transfer tube in the storage dewar only.
  - c. Reduce the boiloff pressure by venting.
  - d. Close the low-pressure safety vent valve on the storage dewar.
  - e. Pressurize the dewar. Set flow to 4 on the flowmeter (pressure will slowly rise). Wait for the dense, white, “flame-like” exit gas from the deflector nozzle (while waiting, release the internal pressure from the magnet slowly). Vent the storage dewar pressure (leave dewar vent open to prevent pressure buildup).
4. Insert the transfer tube and repressurize the storage dewar, as follows:
  - a. Wipe to clear any ice build up at the deflector nozzle.
  - b. Open the magnet entry port.
  - c. Lift up and insert the transfer tube into both dewar and magnet (lower to the insertion stop located on the transfer tube magnet side).
  - d. Close the dewar vent (the flowmeter should still be set to 5). Pressure should slowly rise.
5. Start the fill. While filling, pressure in the dewar should slowly rise.
6. When the exit cloud is accelerated and shows increased density, filling is complete. Complete the transfer as follows:

- a. Vent the storage dewar pressure.
- b. Remove the transfer tube from both the dewar and the magnet.
- c. Close and cap the storage dewar and the magnet.
- d. Open the low-pressure safety valve on the storage dewar.
- e. Close off the helium gas source.

## 8.3 Continuing Dewar Service

This section describes servicing a dewar with liquid helium after the liquids have dropped to the point where refilling (topping off) is necessary. Because of its very low latent heat of vaporization, LHe must be transferred through a well-insulated vacuum jacketed tube.

- “Liquid Helium Service,” next
- “Helium Refilling on Oxford 200- and 300-MHz Magnets,” page 114
- “Determining Stinger Lengths for Storage Containers,” page 115
- “Sample Scoring Problems,” page 116

**WARNING:** Before attempting any transfer of liquid helium or liquid nitrogen, know the safety precautions and operating instructions for the hardware in use. Serious injury can occur in the handling of very cold gases and liquids.

### Liquid Helium Service

Before the transfer occurs, *the transfer tube must be precooled*. Precooling takes from 10 to 40 seconds. Immediately after precooling, the transfer tube is inserted into the magnet dewar and the transfer of LHe initiated. Difficulties in filling occur if unnecessary delays occur between precooling and insertion of the transfer tube.

**CAUTION:** When servicing with helium, do not bend or twist the transfer tube when inside the magnet neck tube because the tube is thin-wall stainless steel and is easily punctured with sharp objects. When clearing ice plugs, use the supplied clean-out tube.

1. Position the LHe storage container with the discharge port about 26.5 in. (68 cm) horizontally from the HELIUM SERVICE port, so that the transfer tube can be inserted into the storage container and the magnet HELIUM SERVICE port simultaneously. (This distance applies only to the LHe transfer tube available from Varian.)
2. Make sure that the helium gas storage cylinder is equipped with a pressure regulator having a range of 2 to 10 psig.
3. *Measure the amount of LHe in the storage container and in the magnet dewar to be sure of a sufficient supply to top off the magnet. Attempting to top off the dewar with a minimal supply could result in a quench. The available liquid helium in the storage container is not the capacity of the storage dewar or the amount of liquid helium in the dewar upon its delivery. The available liquid helium is the amount of liquid helium accessible to the transfer tube with a stinger.*
4. Make sure, by measurement, that the tip of the transfer tube (that is, the end of the stinger if used) on the storage container side reaches to within 2 cm of the bottom of



the dewar when the stop tab on the magnet side of the transfer tube is resting on the lip of the magnet HELIUM SERVICE port. Check that the deflector nozzle is attached to the magnet end of the transfer tube.

5. Depressurize the storage container. During shipment and non-use time, the storage dewar may build up internal pressure.
6. Place the pressurizing collar on the storage container side of the transfer tube.
7. *Precool the helium transfer tube* by slowly inserting one end into the storage dewar with the other end open to the room (see **Figure 30**). Do not close the storage dewar exhaust port during insertion. The heat of the transfer tube (room temperature) will cause increased liquid helium boiloff while being inserted. This helium boiloff should *not* be allowed to build up inside the storage dewar causing pressure.

Once the transfer tube is fully inserted, pressurize the storage dewar by closing the exhaust port. Adjust the flowmeter valve so that the flow rate is about 5 on the scale. The pressure will rise slowly. After 10 to 40 seconds, a plume of LHe (in the form of a very dense, milk-like white, flamed-shaped fog) emerges from the deflector nozzle, indicating that the precooling has been accomplished.

8. After observing the exhaust for 5 to 15 seconds, depressurize the storage dewar by opening the exhaust port.

If the transfer tube frosts over or condenses moisture from the room air (in areas not directly exposed to cold exhaust), it is likely that there is a poor or faulty vacuum within the transfer tube jacket. The transfer tube should be removed from use, warmed, and pumped down to 5 microns (5 millitorr) or better.

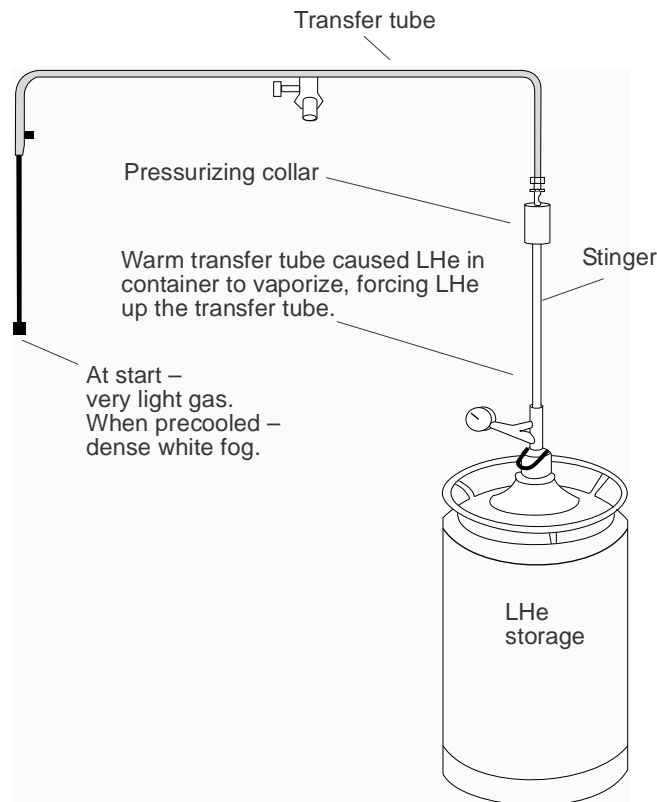
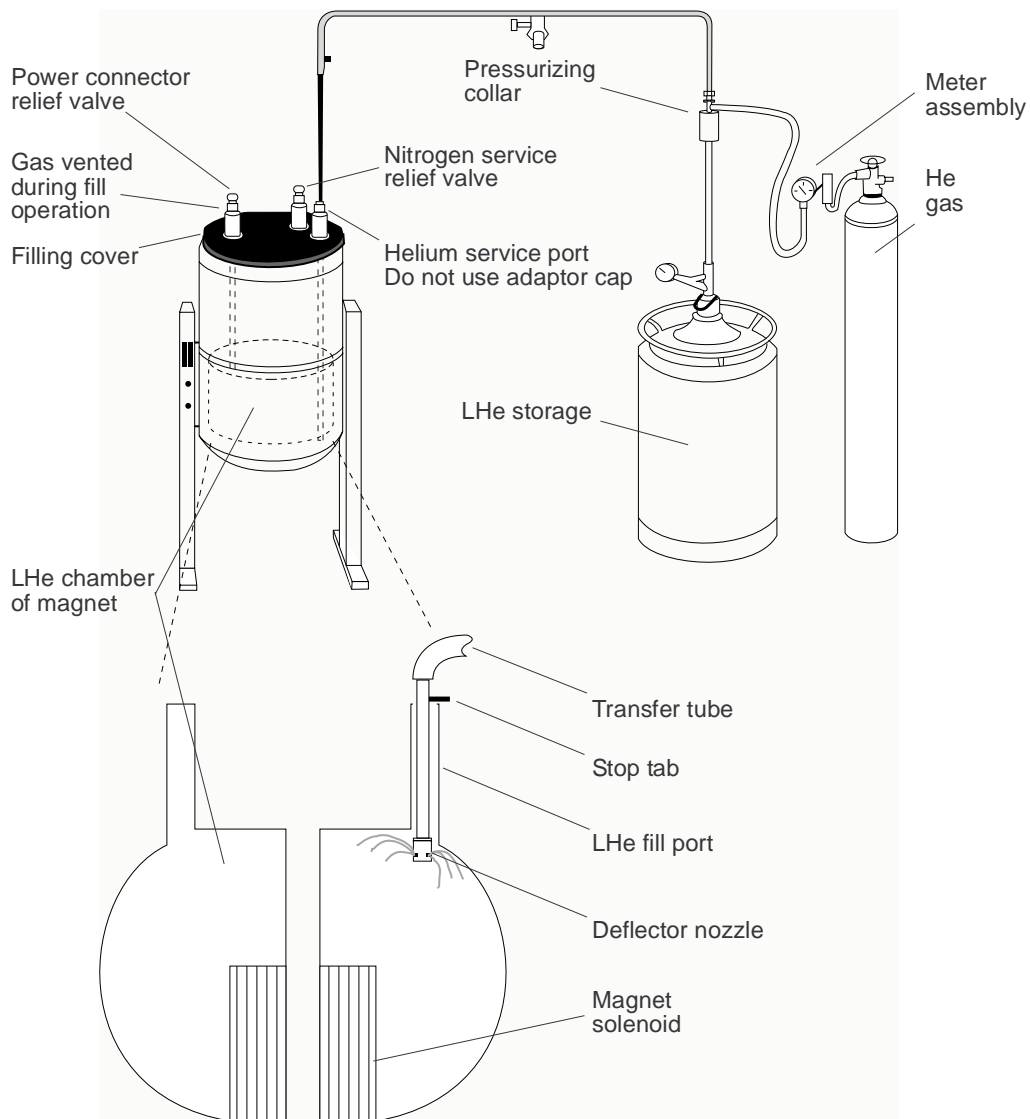

**Figure 30.** Precooling the Liquid Helium Transfer Tube

9. Pull the transfer tube up enough to clear the magnet dewar. Remove the HELIUM SERVICE filling port cap. Swing the transfer tube over the magnet and immediately insert it slowly into the magnet LHe access port and the storage container simultaneously (see [Figure 31](#)). As a guide, use 10 to 15 seconds for insertion up to the stop tab.

If you observe excessive turbulence or a sudden increase in the exhaust rate, the transfer tube insertion is too rapid and hot gas is reaching the LHe in the magnet dewar. This can cause a quench when the LHe level is below the top of the solenoid. The insertion rate should be slowed down.

10. Once the transfer tube is fully inserted so that the stop disk rests on the lip of the magnet access port, start to pressurize the storage dewar by closing the storage container exhaust port. The flow rate of approximately 5 on the scale is still present and will now pressurize the dewar.



**Figure 31.** Routine Filling of the Magnet Dewar

**CAUTION:** Watch the pressure gauge on the gauge head assembly. Any rapid pressure buildup may indicate a frozen air or water blockage in the transfer tube or the fill tube. If ice blockage occurs, halt the LHe transfer, remove the LHe transfer line, and again purge the line with gaseous helium. After the line is cleared, restart the transfer from the beginning. Be sure to plug the storage container and the HELIUM SERVICE port as soon as the LHe transfer tube is removed from them in order to prevent air and moisture from entering the dewars.

Open the vent port of the magnet on the filling side only.

The pressure will rise slowly toward 1 psig. During the 15 seconds to 1 minute, a collapsing exhaust plume is usually observed. The collapsing exhaust indicates that the liquid helium is reaching the magnet end of the transfer tube and is filling the magnet.

If the pressure is not increasing toward 1 psig when the flowrate is set to 5 on the scale, there may be a leak of the pressurizing gas that is preventing the storage dewar from being pressurized.

If the pressure exceeds 2 psig when the flowrate is set to 5, it is likely a blockage has occurred in the transfer tube. It will be necessary to remove the transfer tube, cap the magnet, warm the transfer tube, and start over again at the precooling step.

If a frost spot occurs in any section of the transfer tube that is not directly exposed to cold exhaust, there is probably a metal to metal touch across the vacuum jacket. The transfer tube should be replaced. A defective transfer tube can cause a magnet quench. Varian recommends that you observe the transfer tube for normal operation at each use. The transfer tube can be routinely pumped down once or twice a year as preventive maintenance.

11. The filling continues at this pressure and rate until the magnet dewar is full, which is indicated by a marked increase in the rate of exhaust from the magnet access port. This increased exhaust is accompanied by an increase in the density of the exhaust cloud. If there is any doubt about the dewar contents level, use a flutter tube measurement to verify.
12. Depressurize the storage dewar. Remove the transfer tube from both containers. (Removal is much less risky than insertion.) Cap the magnet access port. Close the appropriate storage dewar valves.

## Helium Refilling on Oxford 200- and 300-MHz Magnets

To maintain optimum refill safety and minimize the risk of accidental quenches, follow these special recommendations when refilling Oxford 200- and 300-MHz magnets:

- When you start filling the magnet (particularly if the helium level is low), open *only* the vent port on the side on which the transfer tube is inserted. Although this procedure should fill most magnets completely, some magnets are only partially filled.
- If a magnet is only partially filled with the vent port open, wait several minutes until the transfer has stabilized (indicated by the collapsing of the initial plume), and then open the port on the demountable lead side. If the second port is opened too soon after filling with the vent port open, warm gases could be sent across the solenoid.
- Under no circumstances should LHe be transferred with the port on the transfer tube side closed and the port on the demountable lead side open.

## Determining Stinger Lengths for Storage Containers

A stinger may be necessary to extend the transfer tube into the LHe storage container. Refer to [Figure 32](#) for the measurements needed to determine the stinger length for a storage container. Take the following steps for each container:

1. Measure distance A, the top of the storage container storage port to the bottom of the liquid helium chamber (a flutter tube can be used for this purpose).
2. Measure distance B, the top of the storage container service port to the top of the liquid helium chamber (a stiff wire with a crimp on the bottom to catch at the top of the chamber works well).
3. Subtract B from A to obtain the depth of the liquid helium chamber. This is measurement C, *the maximum length of a stinger for this container*.

**CAUTION:** The stinger on the storage container side of the transfer tube must not be longer than the height of the LHe chamber (distance C). Exceeding this maximum will cause filling difficulties and can cause a quench.

The following steps identify whether an elevating platform is needed below the storage dewar. Because the stinger has a limit to its maximum length, and the transfer tube cannot be lowered further than the stop disk allows (on the magnet side), an elevating platform for the storage dewar may be required to enable the stinger entry tip to reach the LHe to be transferred.

1. Measure distance D, the bottom of the liquid helium chamber to the floor.
2. Add C to D to give the distance from the top of the LHe chamber to the floor.

- If this distance is 26 inches or greater, then you will be able to fill from this container without an additional platform to elevate the storage dewar (this distance applies only to the LHe transfer tube available from Varian.).
- If this distance is less than 26 inches, constructing a platform under the storage container is necessary before proceeding. The platform must be designed to elevate the container so that the storage chamber top (C + D in [Figure 32](#)) is level with or higher than 26 inches above floor level. The design of the platform must also allow the storage container to be positioned with its service port 68 cm (26 3/4 in.) from the HELIUM SERVICE port on the magnet, as measured on a horizontal line that simulates the transfer tube.

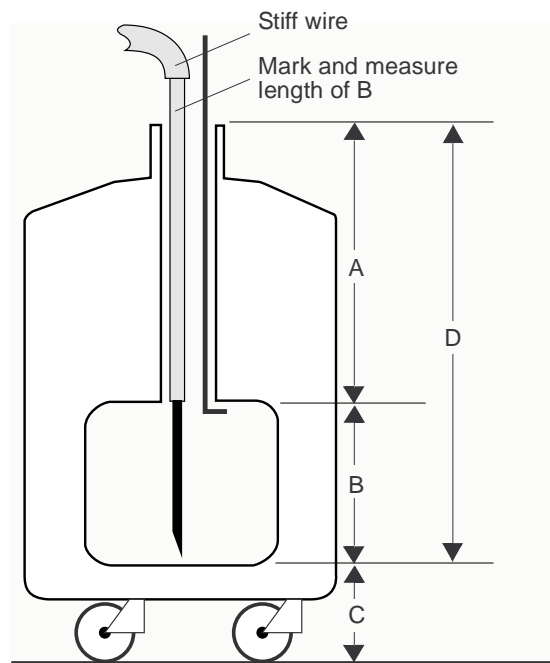

**Figure 32.** Stinger Configuration Measurements on the Storage Container

## 8.4 Troubleshooting

- “Sample Changer Troubleshooting,” next
- “Sample Changer Troubleshooting,” next
- “Other Troubleshooting Solutions,” next

### Sample Scoring Problems

Sample scoring and spinning instabilities are often caused by improper mating between the upper barrel and the probe. The following spin test checks for this problem.

1. Cover the sample tube using a felt-tipped ink marker pen (blue or black ink is best).
2. Let the sample spin for 1 to 3 hours in the magnet.

Any scoring should show up clearly in the inked sample tube. If scoring is evident, perform the following:

1. Loosen the probe flange thumbscrews one full turn and retighten them without twisting the probe body.
2. Spin test the sample again.

If scoring is still present, follow this procedure:

1. Loosen the upper barrel thumbscrews one full turn.
2. Loosen the probe flange thumbscrews one full turn.
3. Semi-loosen the probe flange set screws.
4. Push up on the probe body until the upper barrel moves approximately 1 inch.
5. Push down on the upper barrel until it hits the stops.
6. Tighten the probe flange set screws and thumbscrews.
7. Tighten the upper barrel thumbscrews.
8. Insert the sample and spin test for scoring.

If scoring is still evident, perform steps 1 to 8 again. If the scoring continues, contact you field service engineer.

### Sample Changer Troubleshooting

Some problems that can be dealt with by the user are the following:

#### ***Sample Changer Not Responding***

On the SMS sample changer, first check that the emergency stop button is off, then check the power switches on the back of the System V control and the robot. Also check the cable from System V control to the NMR console.

On the ASM-100 sample changer, check the power switch on lower rear of sample changer, check that RS-232 cable to sample changer is connected, and check whether any fuses in the sample changer are blown.

### ***Gripper Drops Sample Back into Magnet when Sample is Ejected***

On the SMS sample changer, check for bent fingers.

On the ASM-100 sample changer, gripper is not grasping enough of spinner— raise air pressure to sample changer by 1 to 2 pounds, or adjust the height of the gripper retrieval (bottom) position.

### **Other Troubleshooting Solutions**

#### ***Spinner does not rotate.***

Remove, disassemble, and clean upper barrel with ethanol.

#### ***Magnet has high boil off.***

Check for ice in the power connector.



## Appendix A. Acquisition CPU Initialization

If a new Acquisition CPU is installed in the console, it might be necessary to initialize the NVRAM information on this CPU. The procedure in this appendix describes how to enter the information into the NVRAM using VxWorks.

1. Attach a terminal (or SUN window) according to one of the following:
  - For *UNITYINOVA* – attach a terminal (or SUN window) to the diagnostic port on the back of the console. This system comes with a Motorola 162 or Motorola PPC.
  - For *MERCURYplus/-Vx* – attach a terminal (or SUN window) to port 1 (Console) on the Acquisition CPU. You can temporarily use the spinner cable if you add a null modem.
2. Reset the Acquisition CPU and press any key during the count down to prevent the CPU from booting up. This brings the Acquisition CPU into VxWorks.

The [vxWorks] : prompt appears.

3. Enter **c** and press Return to enter the VxWorks *command mode*:

```
[vxWorks] : c
```

VxWorks responds with a “prompt : value” for each option. The list below shows the values, in bold, that must be entered. [Table 10](#) lists the entry and action for each prompt.

**Table 10.** VxWorks Prompts, Values, and Descriptions

| Prompt                           | Motorola 162              | Motorola PPC                       | Description    |
|----------------------------------|---------------------------|------------------------------------|----------------|
| [vxWorks]:                       | <b>c</b>                  | <b>c</b>                           | Type the c     |
| boot device:                     | <b>ei</b>                 | <b>dc</b>                          | Set to ei / dc |
| processor number:                | <b>0</b>                  | <b>0</b>                           | Set to zero    |
| host name:                       | .                         | .                                  | Clear          |
| file name:                       | .                         | <b>/tftpboot/vxBoot/vxWorksPPC</b> | Clear or Set   |
| inet on ethernet (e):            | .                         | .                                  | Clear          |
| inet on backplane (b):           | .                         | .                                  | Clear          |
| host init (h):                   | .                         | .                                  | Clear          |
| gateway inet (g):                | .                         | .                                  | Clear          |
| user:                            | <b>vnmr1</b>              | <b>vnmr1</b>                       | Set to vnmr1   |
| ftp passwd (pw) (blank—use rsh): | .                         | .                                  | Clear          |
| flags:                           | <b>0xca</b>               | <b>0xca</b>                        | Set to 0xca    |
| target name (tn):                | .                         | .                                  | Clear          |
| startup scripts (s):             | <b>/vnmr/acq/vwScript</b> | <b>/vnmr/acq/vwScriptPPC</b>       | Script name    |
| other:                           |                           |                                    | Clear          |

4. Take one of the following actions for each prompt:
  - If the value in the prompt is correct, press Return.



- If the value in the prompt is incorrect, enter the correct value as shown below in bold.
- If the value in the prompt is to be blank, type period (.) and press Return to clear the value.

```
[vxWorks]: c
boot device: ei (dc for PPC)
processor number: 0
host name:
file name: (/tftpboot/vxBoot/vxWorksPPC for PPC)
inet on ethernet (e):
inet on backplane (b):
host init (h):
gateway inet (g):
user: vnmr1
ftp passwd (pw) (blank—use rsh):
Flags: 0xca
target name (tn):
startup scripts (s): /vnmr/acq/vwScript
(/vnmr/acq/vwScriptPPC for PPC)
other:
```

5. To restart the bootup process, enter:  
[vxWorks]: **@**
6. Open a Sun shell window and as root, enter the following command:  
**# /vnmr/bin/setacq**  
Answer the questions as they appear.

When the small kernel is used, startup script(s) can be left blank. It must be set when vxboot.big is used; it is ignored when vxboot.small is used (our default).

## Appendix B. Hardware Reference Information

### Shim Gradient Supply Data Connection on <sup>UNITY</sup>INOVA

Due to a problem with the MSR (Magnet and Sample Regulation) board on early <sup>UNITY</sup>INOVA systems, the shim supply on these spectrometers was connected to the Acquisition CPU board. In the meantime, the MSR boards in these systems should have been retrofitted (modified) by Varian service. If you find that on your <sup>UNITY</sup>INOVA the shims cable (Part No. 01-903415-00 for Varian shims, 01-905599-00 for RRI shim modules) is still plugged into the Acquisition CPU board (RJ45 connection on serial port 2, J17-2), you should move that connection to the MSR board (serial port 1, J1-1) and reboot the console.

If you are using VNMR 6.1A or an earlier version and observe problems with the shims connected to the MSR board, you should contact Varian service to fix the MSR board prior to loading VNMR 6.1B or a later version or VnmrJ. MSR board upgrades and fixes are described in the service bulletins MP950011 (lock display problem), MP960006, and MP980004 (boot-up problems).

VNMR 6.1B and later versions *require* the shims to be plugged into the MSR board. Without this, you will be unable to load shims, and gradient shimming will reset all shims to zero. Note that the original <sup>UNITY</sup>INOVA RRI serial cable, Part No. 01-903416-00, went from the CPU or MSR boards to the Breakout Panel, requiring a separate cable between the console and the RRI Module. This cable has been replaced by cable 01-905599-00. The 14-Channel Shim Supply uses a flat ribbon cable, 00-958408-10, that makes the connection from J11 of the MSR board to J11 of the 14-Channel Shim Supply.



## Appendix C. Printers and Plotters Troubleshooting

Sections in this appendix:

- C.1, “Configuring Printer and Plotter Hardware,” this page.
- C.2, “Printer Troubleshooting and Hints,” on page 130.

This appendix contains troubleshooting and setup information for printers and plotters.

### C.1 Configuring Printer and Plotter Hardware

This section describes a number of printers and plotters tested as compatible with VnmrJ. Check the Varian website for new printers that work with VnmrJ. For printers supplied with older spectrometers, refer to the original system manuals supplied with the printer or refer to the on-line manuals. The following printers and plotters are covered in this manual:

- “Hewlett-Packard LaserJet 840C Printer,” next
- “Lexmark Optra Color 45 Inkjet Printer” on page 124
- “Hewlett-Packard DeskJet 5550 Printer” on page 126
- “Hewlett-Packard DeskJet 970Cxi Printer” on page 127
- “Hewlett-Packard LaserJet 2300 Printer” on page 127
- “Hewlett-Packard LaserJet 2100 Printer” on page 128
- “Hewlett-Packard Color LaserJet 4550 Printer” on page 128
- “Hewlett-Packard Color Inkjet CP1700 Printer” on page 130

#### Hewlett-Packard LaserJet 840C Printer

|                              |                                                                                        |
|------------------------------|----------------------------------------------------------------------------------------|
| <i>Printer I/O</i>           | HP IEEE-1284-B Parallel<br>Universal serial bus<br>1284-B receptacle                   |
| <i>Printer Language</i>      | HP PCL 3.                                                                              |
| <i>Printer Memory</i>        | 2 MB standard memory                                                                   |
| <i>Cartridges</i>            | black and color                                                                        |
| <i>Resolution</i>            | Black – 600 x 600 dpi with black pigmented ink<br>Color – HP color layering technology |
| <i>Pages per Minute</i>      | Black – 4 ppm<br>Black and color – 0.8 ppm                                             |
| <i>Configuration Control</i> | Software controlled.                                                                   |

There are two buttons and three lights on the front of the printer. The lights indicate when the printer is operating correctly or when it needs attention from you and the buttons are used to control the printer.

### Self-Test Procedure

1. Turn the HP DeskJet 810C and 830C series printer off and remove the cable that connects the printer to the computer.
2. Turn the printer back on.
3. Press and hold the **Power** (top) button. Press the **Resume** button 4 times and then release the **Power** button.
4. The self-test page will print with a report containing the printer model name, serial number and a diagonal self-test pattern. The test pattern verifies that all nozzles on the print cartridge are firing. If a gap appears along the diagonal self-test pattern, one or more nozzles are not firing.

### Operation

1. With the power off, connect the interface and power cables. Press **go** to turn the power on. The ready light should come on.
2. Open a UNIX window, log in as `root`, and activate `LaserJet_150`, `LaserJet_150R`, `LaserJet_300`, `LaserJet_300R`, `LaserJet_600`, and `LaserJet_600R` using the procedures in the beginning of this chapter.
3. From within `VnmrJ`, set the parameter `printer` to the name you entered in the previous step, for example, `printer='LaserJet_300'` or `printer='lj'`. Enter `printon dg printoff` to produce a test print.

To use as a plotter, set the parameter `plotter` to the name you entered in the previous step, for example, `plotter='lj 300'` (If you activated more than one resolution, there will be different names corresponding to the different resolutions). To test, enter `pl page`.

## Lexmark Optra Color 45 Inkjet Printer

|                              |                                                                                  |
|------------------------------|----------------------------------------------------------------------------------|
| <i>Printer I/O</i>           | IEEE 1284 ECp compliant, 1284-B receptacle, Internal Solutions Port (6 options). |
| <i>Printer Language</i>      | PostScript Level and PCL 5c emulation.                                           |
| <i>Printer Memory</i>        | 8 MB.                                                                            |
| <i>Cartridges</i>            | Dual head thermal inkjet                                                         |
| <i>Resolution</i>            | 600 x 600 dpi                                                                    |
| <i>Pages per Minute</i>      | Black - 8 ppm<br>Color - 4 ppm                                                   |
| <i>Configuration Control</i> | Software controlled.                                                             |

The Varian supplied customized Optra Color 45 printer/plotter includes special software and is HPGL, PS, and PCL compatible. This custom printer is not available from other sources. The optional tri-port serial port board is installed in the Varian Optra Color 45 allowing either serial or parallel port mode. The Optra Color 45 replaces the Lexmark 4079, HP 7475, and the HP 7550A plotters.

### Self-Test Procedure

1. Follow the set up instructions in the printer manual and then plug into ac power.
2. The print display should show **Ready** and the green light is **on**.

3. Press the **Menu** button until **TESTS MENU** is displayed and push **Select**.
4. Press the **Menu** button until **Print Demo** is displayed and push **Select** twice.
5. A multi-color page should be printed and the Menu returns to **Ready**.

### *SUN Computer Page Size Setup*

To plot on 11 x 17 paper (the default printer option is 8.5 x 11 paper), the menu selection on the Optra Color 45 and the VnmrJ software must be changed.

#### *Optra Color 45 Menu Selection*

1. Push the **Menu** button to scroll through the setup options to the **Paper** Menu and push the **Select** button.
2. Push the **Menu** button to scroll to the **Paper Size** option and push the **Select** button.
3. At **Tray 1 Size** push the **Select** button.
4. Push the **Menu** button to scroll through the **paper size** options and push **Select** to save the desired paper size.
5. Push the **Go** Button to return to the **Ready** state.

#### *Software Edit*

You will have to edit, copy and paste within the `devicetable` file in `/vnmr` to change the x and y plot size from the default 8.5" x 11"(Letter) paper to 11" x 17" paper.

When installing the Optra Color 45 with `/vnmr/bin/. /adddevices` on a Sun computer, Postscript (PS) is the best `Printer type` to use. If you choose the HP 7550 or the HP 7475 for HPGL the resolution is much less than the PS resolution.

**WARNING: DO NOT set the Optra Color 45 to the `Lexmark Printer type`. The printer will not work.**

### *SUN Serial Port Setup*

It is best to run the Optra Color 45 on the SUN parallel port, but if you already have a printer/plotter on the parallel port, the Optra Color 45 can use a serial port. The serial port default speed is 9600 on the Optra Color 45 and the Sun, but the Optra Color 45 will run at the baud rate of 38400 for faster printing/plotting. If you are having problems printing/plotting, it is a good idea to check the serial port settings with `admintool`. You must be root to use `admintool`, and it is run from a shell tool.

#### *Admintool - Change to Serial Port*

After opening `Admintool` do the following:

- Click on **Browse**
- Click on **Serial Ports**
- Double click on **a** or **b** to open up `Modify Serial:Port`
- The `Template` window should be `Terminal-Hardware`, change if necessary.
- Click on the **Baud Rate** box to change the baud rate.
- Click on **expert**.

### *Optra Color 45 Change to Serial Port*

The Optra Color 45 Menu Selection for serial port is:

1. Push the **Menu** button to scroll to the **Serial** Menu and push the **Select** button, **SERIAL OPTION 1** is displayed.
2. Push the **Select** button to select **SERIAL OPTION 1** level.
3. Push the **Menu** button to scroll to **Baud option** and push **Select**.
4. Push the **Menu** button to scroll to the desired (recommend 38400) baud rate.
5. Push **Select** to save the baud rate.
6. Push the **Go** button to return to the **Ready** menu.

## **Hewlett-Packard DeskJet 5550 Printer**

|                              |                                                                         |
|------------------------------|-------------------------------------------------------------------------|
| <i>Printer I/O</i>           | Centronics Parallel<br>Universal serial bus                             |
| <i>Printer Language</i>      | HP PCL 3, PostScript                                                    |
| <i>Printer Memory</i>        | 512 Kbyte standard memory sufficient for full page graphics at 600 dpi. |
| <i>Cartridges</i>            | black and color                                                         |
| <i>Resolution</i>            | Black – 600 x 600 dpi<br>Color – depends on paper type                  |
| <i>Pages per Minute</i>      | Black – 12 ppm<br>Black and color – 10 ppm                              |
| <i>Configuration Control</i> | Software controlled.                                                    |

The Hewlett-Packard 5550 features 600 dpi color printing and is software controlled. It has a color cartridge and a black cartridge. The control panel has two switches. Refer to the Hewlett-Packard manual for operating procedures.

There are three buttons. The power button and light should always be used to turn the printer on and off. Using a power strip, surge protector, or a wall-mounted switch to turn on the printer may cause premature printer failure.

The cancel button stops the print task.

The resume button and light is used when the light above the resume button is flashing. Press the button to continue printing.

Varian software does not support two sided printing.

## Hewlett-Packard DeskJet 970Cxi Printer

|                              |                                                                         |
|------------------------------|-------------------------------------------------------------------------|
| <i>Printer I/O</i>           | Centronics Parallel<br>Universal serial bus<br>1284-B receptacle        |
| <i>Printer Language</i>      | HP PCL 3.                                                               |
| <i>Printer Memory</i>        | 512 Kbyte standard memory sufficient for full page graphics at 600 dpi. |
| <i>Cartridges</i>            | black and color                                                         |
| <i>Resolution</i>            | Black – 600 x 600 dpi<br>Color – depends on paper type                  |
| <i>Pages per Minute</i>      | Black – 12 ppm<br>Black and color – 10 ppm                              |
| <i>Configuration Control</i> | Software controlled.                                                    |

The Hewlett-Packard 970CXI features 600 dpi color printing and is software controlled. It has a color cartridge and a black cartridge. The control panel has two switches. Refer to the Hewlett-Packard manual for operating procedures.

There are three buttons. The power button and light should always be used to turn the printer on and off. Using a power strip, surge protector, or a wall-mounted switch to turn on the printer may cause premature printer failure.

The cancel button stops the print task.

The resume button and light is used when the light above the resume button is flashing. Press the button to continue printing.

Varian software does not support two sided printing.

## Hewlett-Packard LaserJet 2300 Printer

|                              |                                            |
|------------------------------|--------------------------------------------|
| <i>Printer I/O</i>           | Centronics Parallel,<br>USB port           |
| <i>Printer Language</i>      | HP PCL 6                                   |
| <i>Printer Memory</i>        | 4 MB standard memory (expandable to 52 MB) |
| <i>Cartridges</i>            | black                                      |
| <i>Resolution</i>            | 1200 x 1200 dpi                            |
| <i>Pages per Minute</i>      | 10 ppm                                     |
| <i>Configuration Control</i> | Software controlled.                       |
| <i>Devicetable entry</i>     | LaserJet_600 and LaserJet_600R             |

The Hewlett-Packard LaserJet 2100 features 1200 dpi printing and is software controlled. The control panel has two switches and two lights. Refer to the Hewlett-Packard manual for operating procedures.

### Self-Test Procedure

To print the configuration page, press and release the **go** (large button at bottom of control panel) and **job cancel** (button at top of control panel with upside down triangle) buttons simultaneously when the printer is in the ready mode.



## Hewlett-Packard LaserJet 2100 Printer

|                              |                                                          |
|------------------------------|----------------------------------------------------------|
| <i>Printer I/O</i>           | Centronics Parallel, 1284-B receptacle<br>LocalTalk port |
| <i>Printer Language</i>      | HP PCL 6                                                 |
| <i>Printer Memory</i>        | 4 MB standard memory (expandable to 52 MB)               |
| <i>Cartridges</i>            | black                                                    |
| <i>Resolution</i>            | 1200 x 1200 dpi                                          |
| <i>Pages per Minute</i>      | 10 ppm                                                   |
| <i>Configuration Control</i> | Software controlled.                                     |

The Hewlett-Packard LaserJet 2100 features 1200 dpi printing and is software controlled. The control panel has two switches and two lights. Refer to the Hewlett-Packard manual for operating procedures.

### Self-Test Procedure

To print the configuration page, press and release the **go** (large button at bottom of control panel) and **job cancel** (button at top of control panel with upside down triangle) buttons simultaneously when the printer is in the ready mode.

## Hewlett-Packard Color LaserJet 4550 Printer

|                               |                                                                                                                                                                                                                                                                                                                                                                                                             |
|-------------------------------|-------------------------------------------------------------------------------------------------------------------------------------------------------------------------------------------------------------------------------------------------------------------------------------------------------------------------------------------------------------------------------------------------------------|
| <i>Printer I/O</i>            | Bidirectional parallel port (requires a “C” connector),<br>Two Enhanced Input/Output (EIO) slots; paper handling<br>accessory port; infrared receiver port.<br>IEEE compliant, 1 open EIO slot, HP JetDirect EIO<br>print server for fast Ethernet 10/100Base-TX in second<br>EIO slot.<br>(optional) HP JetDirect 600N and 610N (EIO) internal<br>print servers, external print servers, connectivity card |
| <i>Printer Language</i>       | HP PCL 5C, PostScript Level 3 Emulation, HP PCL 6                                                                                                                                                                                                                                                                                                                                                           |
| <i>Printer Memory</i>         | 64 MB standard memory (expandable to 192 MB)                                                                                                                                                                                                                                                                                                                                                                |
| <i>Resolution</i>             | 600 dpi                                                                                                                                                                                                                                                                                                                                                                                                     |
| <i>Pages per Minute</i>       | 16 ppm (black); 4 ppm (color)                                                                                                                                                                                                                                                                                                                                                                               |
| <i>Configuration Switches</i> | Expanded Control Panel                                                                                                                                                                                                                                                                                                                                                                                      |

### Operation

Set up the printer as described in the Hewlett-Packard manual. Specify the printer as a PostScript printer. On the Name and Type lines in the file `/vnmr/devicenames`, enter PS for a printer and PS\_AR for a plotter. In the user’s `global` file, set `maxpen=8`.

## Hewlett-Packard LaserJet 5000 Series Printers

|                               |                                                                                        |
|-------------------------------|----------------------------------------------------------------------------------------|
| <i>Printer I/O</i>            | IEEE 1284-compliant bidirectional parallel, RS-232 9-pin serial, 2 PCI-based EIO slots |
| <i>Printer Language</i>       | HP PCL 5e, HP PCL 6, and Postscript Level 2 emulation                                  |
| <i>Printer Memory</i>         | 4 MB standard memory (expandable to 100 MB)                                            |
| <i>Resolution</i>             | 1200 dpi                                                                               |
| <i>Pages per Minute</i>       | 16 ppm                                                                                 |
| <i>Configuration Switches</i> | Control Panel                                                                          |

### Overview

The Hewlett-Packard 5000 provides large format (11 x 17") printing at 16 pages per minute. The control panel has an LCD display, three LEDs and six buttons.

The LaserJet 5000 features 1200 dpi resolution, but for NMR typical applications the plot lines are too fine. You may even fail to plot a full page at this resolution without expanding the printer memory since a full 11 x 17" page takes up to 32 MBytes of pixel information. Also even in parallel interface applications transferring data is unacceptably slow. For good plot resolution, 600 dpi is a good choice; for publication quality spectra and reproduction 300 dpi is a better option since the plot looks darker.

Switching between large and standard formats requires changing the paper size in the printer configuration menu on the LaserJet 5000.

### Self-Test Procedure

1. Load paper and toner cartridge. Press the **Go** button to turn printer on. Wait until the printer warms up.
2. The **READY** message should be displayed.
3. Press **Menu** until the display reads **INFORMATION MENU**.
4. Press **Item** until the display reads **PRINT CONFIGURATION**.
5. Press **Select** to print the configuration page.
6. The configuration page shows the printer's current configuration.

### Operation

Set up as described in the Hewlett-Packard printer manual.

## Hewlett-Packard Color Inkjet CP1700 Printer

|                         |                                                                                                                                                                                                                                                                                                                                          |
|-------------------------|------------------------------------------------------------------------------------------------------------------------------------------------------------------------------------------------------------------------------------------------------------------------------------------------------------------------------------------|
| <i>Printer I/O</i>      | Bidirectional parallel port (requires a “C” connector)<br>Two Enhanced Input/Output (EIO) slots<br>Paper handling accessory port<br>Infrared receiver port.<br>USB, IEEE-1284 (parallel), Infrared, and network LIO.<br>(optional) HP JetDirect 600N and 610N (EIO) internal<br>print servers, external print servers, connectivity card |
| <i>Printer Language</i> | HP color Inkjet cp1700: HP PCL 3 enhanced<br>HP color Inkjet cp1700d: HP PCL 3 enhanced<br>HP color Inkjet cp1700ps: HP PCL 3 enhanced                                                                                                                                                                                                   |
| <i>Printer Memory</i>   | 16 megabyte (MB) built-in random access memory<br>(RAM), cannot be upgraded.<br>4 megabytes (MB) built-in read only memory (ROM),<br>cannot be upgraded                                                                                                                                                                                  |
| <i>Resolution</i>       | 1200 x 1200 dpi (black); 2400 x 1200 dpi (color)                                                                                                                                                                                                                                                                                         |
| <i>Pages per Minute</i> | 16 ppm (black); 14.5 ppm (color)                                                                                                                                                                                                                                                                                                         |

### Overview

The control panel has an LCD display representing ink levels and printer status. There are also three push buttons to control power on/off, resume, and cancel. The resume and power switches have a LED associated with them.

The CP1700D features 1200 dpi resolution for black and white printing and 2400 dpi for color, but for NMR typical applications the plot lines are too fine. It might not be possible to plot a full page at this resolution without expanding the printer memory because a full 11 x 17 page takes up to 32 MBytes of pixel information. Also, even in parallel interface applications transferring data is unacceptably slow. For good plot resolution, 600 dpi is a good choice; for publication quality spectra and reproduction 300 dpi is a better option since the plot looks darker.

### Self-Test Procedure

1. Load paper, ink tanks, and print heads.
2. Press the power button to turn printer on. Wait until the printer initializes and reports Ready.
3. Press and hold the **resume** button on the control panel for three seconds until the LCD display reports `processing Job`.
4. Release the button. A test page is automatically printed.

### Operation

Set up as described in the Hewlett-Packard printer manual.

## C.2 Printer Troubleshooting and Hints

The troubleshooting steps and hints in this section should assist you in solving problems with printers. For troubleshooting updates, please check the Varian website.

## Solaris Related

### *Serial Printer Outputs Strange Characters*

If you have a LaserJet series printer that prints strange characters, the following steps should fix the problem

1. Open a Command Tool or Terminal Window.  
Move the mouse pointer to an empty part of the screen and press the right button. Drag down to Programs to open the popup menu, and select a terminal window.
2. Change the baud rate to 19200 by entering:  
varian# **stty 19200**
3. Get the report of the terminal's current settings by entering:  
varian# **stty -g**  
The system returns a long list of characters separated by colons. Write down the information for future reference.
4. Become super user:  
varian# **su**  
password: **root\_password**
5. Change to the /kernel/drv:  
varian# **cd /kernel/drv**
6. Make a copy of the options.conf file:  
varian# **cp options.conf options.conf.old**
7. Use a text editor, such as vi, to edit the options.conf file. Find the line towards the bottom of the file that begins `ttymodes="x:x:x"`, where "x:x:x" is the terminal settings.  
Replace the settings between the quotes with what you wrote down from the `stty -g` command.
8. Reboot the computer.

The LaserJet series printer should no longer print strange characters.

### *Parallel Printer Installation on Sun Ultra 5, 10, 30, 60*

Before installing a parallel printer on a Sun PCI-based systems (Ultra 5, 10, 30, 60):

1. Verify that all Solaris 8 patches from Sun are loaded.
2. Using an editor, modify the file `/vnmr/tcl/bin/add_printer` as follows:
3. Change `bpp0` to `ecpp0` in lines 78 and 283.
4. Verify that an IEEE-1284 fully compliant cable is used to connect the parallel printer to the Ultra 5/10/30/60.

**Note:** Varian stocks the IEEE-1284 fully compliant cable under Varian part number 81-839841-00, Centronics to DB 25 M-M.

Install the parallel printer according to the normal procedure.

### Serial or Parallel Printer Port?

If your printer has a parallel printer port, it is best to use the Sun work station parallel port for connection. Serial port printing is slower. There is a program in the `userlib` directory that speeds up the serial port, but the parallel port printer connection is best and easiest to install.

### Do Not Remove or Modify devicenames

A Solaris software upgrade overwrites or removes the `/vnmr/devicenames` file. You must save this file before upgrading. After the upgrade restore this file to your new version and reboot the host computer with the printer on.

Use the `adddevices` command to create a new printer/plotter entry for VNMrvnmr. Do not short cut by modifying `devicenames`. This does not complete the installation of the printer/plotter.

### Use adddevices Menu to Control Printer

To control a printer with the `lp` command, it is necessary to set the desired printer as the default using the `adddevices` menu. “[Managing Printers and Plotters](#)” on page 62 describes the procedure.

### Printing on A3 and B-Size Paper

In order to use A3 format paper on the LaserJet 600R, change two lines in the LaserJet 600R entry:

```
wcmaxmax: 250 to 400
wc2maxmax: 180 to 250
```

To plot on 11 × 17 paper with a Lexmark PS 4079, set:

```
wc2max: 210
wcmax: 400
```

### Controlling LaserJet Plot Quality

The current version of VnmrJ uses various plotter type definitions for PC plotting on LaserJet printer/plotters. [Table 11](#) lists plot resolutions based on definitions from the file `/vnmr/devicetable`.

**Table 11.** LaserJet Plot Resolution

| <i>Plotter Type</i> | <i>Resolution Plot</i> | <i>Orientation</i> |
|---------------------|------------------------|--------------------|
| LaserJet_150        | 150 dpi                | portrait           |
| LaserJet_150R       | 150 dpi                | landscape          |
| Laser3et_300        | 300 dpi                | portrait           |
| LaserJet_300R       | 300 dpi                | landscape          |
| LaserJet_600        | 600 dpi                | portrait           |
| LaserJet_600R       | 600 dpi                | landscape          |

The 600-dpi (dots per inch) definitions offer the highest resolution and a maximum amount of detail, particularly in complex 1D spectra, but at the expense of a data matrix four times

the size of a 300-dpi matrix, or 16 times the size of a 150-dpi matrix. Using 600 dpi may lengthen the plot (data transfer) time considerably, especially when using a serial connection. Older LaserJet models offer only 300 dpi and 150 dpi resolutions.

One disadvantage of 600 dpi plots is that VnmrJ plots lines one pixel wide, resulting in a line width of 0.04 mm. This gives the impression of a faint, gray plot that is often not suited for reproduction and publication. The solution for this problem is simple: if you use a 300 dpi or 150 dpi plotter type definition (see above), then you obtain line widths of 0.085 and 0.17 mm, respectively. This makes the plots look much darker and easier to reproduce for publication.

For optimum results you may want to have multiple plotter definitions (e.g., using the definitions LaserJet\_150R, LaserJet\_300R, and LaserJet\_600R) for the same plotter. This permits adjusting the plot resolution depending on what the output is used for, simply by switching between plotter definitions.

## Generic Solutions

### *Do Not Remove or Modify devicenames*

A Solaris software upgrade overwrites or removes the `/vnmr/devicenames` file. You must save this file before upgrading. After the upgrade restore this file to your new version and reboot the host computer with the printer on.

Use the `adddevices` command to create a new printer/plotter entry for VNMrvnmr. Do not short cut by modifying `devicenames`. This does not complete the installation of the printer/plotter.

### *Use adddevices Menu to Control Printer*

To control a printer with the `lp` command, it is necessary to set the desired printer as the default using the `adddevices` menu. “[Managing Printers and Plotters](#)” on page 62 describes the procedure.

### *Printing on A3 and B-Size Paper*

In order to use A3 format paper on the LaserJet 600R, change two lines in the LaserJet 600R entry:

```
wcmaxmax: 250 to 400
wc2maxmax: 180 to 250
```

To plot on 11 × 17 paper with a Lexmark PS 4079, set:

```
wc2max: 210
wcmax: 400
```

### *Controlling LaserJet Plot Quality*

The current version of VnmrJ uses various plotter type definitions for PC plotting on LaserJet printer/plotters. [Table 11](#) lists plot resolutions based on definitions from the file `/vnmr/devicetable`.

The 600-dpi (dots per inch) definitions offer the highest resolution and a maximum amount of detail, particularly in complex 1D spectra, but at the expense of a data matrix four times the size of a 300-dpi matrix, or 16 times the size of a 150-dpi matrix. Using 600 dpi may

**Table 12.** LaserJet Plot Resolution

| <i>Plotter Type</i> | <i>Resolution Plot</i> | <i>Orientation</i> |
|---------------------|------------------------|--------------------|
| LaserJet_150        | 150 dpi                | portrait           |
| LaserJet_150R       | 150 dpi                | landscape          |
| Laser3et_300        | 300 dpi                | portrait           |
| LaserJet_300R       | 300 dpi                | landscape          |
| LaserJet_600        | 600 dpi                | portrait           |
| LaserJet_600R       | 600 dpi                | landscape          |

lengthen the plot (data transfer) time considerably, especially when using a serial connection. Older LaserJet models offer only 300 dpi and 150 dpi resolutions.

One disadvantage of 600 dpi plots is that VnmrJ plots lines one pixel wide, resulting in a line width of 0.04 mm. This gives the impression of a faint, gray plot that is often not suited for reproduction and publication. The solution for this problem is simple: if you use a 300 dpi or 150 dpi plotter type definition (see above), then you obtain line widths of 0.085 and 0.17 mm, respectively. This makes the plots look much darker and easier to reproduce for publication.

For optimum results you may want to have multiple plotter definitions (e.g., using the definitions LaserJet\_150R, LaserJet\_300R, and LaserJet\_600R) for the same plotter. This permits adjusting the plot resolution depending on what the output is used for, simply by switching between plotter definitions.

## Linux Related

There are no Linux related printer issues at this time.

## Appendix D. Restricting User's Data Viewing Privileges in Locator

The system administrator can restrict how files appear in the locator for each user. An access list controls which users can see which data.

The following steps describe how to set up an access list for a user.

1. Open the **VnmrJ Administration** interface if is not already open.
2. Click the button with the user's name to select the user.
3. Open the **Users Defaults** window (Configure -> Users -> Defaults).
4. Check the **show** column of access.
5. Click **OK**.

An Access line appears in the upper right of the User Info panel.

6. Enter a space-separated list of user whose files the selected user can access.  
For example, if user1 will be allowed to view files for user2, user3, and user99,  
enter: `user2 user3 user99`
7. Click **Save User**.
8. Repeat for each user.





## Appendix E. Browsers

The VnmrJ interface determines the type of browser that is appropriate. The experimental and walkup interfaces use the “[File Browser](#),” next and the imaging interface uses the [E.2](#), “[Image Browser](#),” on page 138.

### E.1 File Browser

There is a file browser that can be operated in conjunction with the Locator. There are three instances of this file, one for each interface:

- experimental  
/vnmr/templates/vnmrj/interface/ToolPanel.xml
- imaging  
/vnmr/imaging/templates/vnmrj/interface/ToolPanel.xml
- walkup  
/vnmr/walkup/templates/vnmrj/interface/ToolPanel.xml

#### Instructions

When the file browser panel is open (non zero size), the Locator limits its scope to only files and directories at the current file browser level or below. Closing the file browser by reducing it to zero size (by clicking the little arrows or dragging the border), will cause the Locator to go back to its unlimited display of items. Drag & drop from Locator to the file browser will set the latter to the director where the dragged item resides.

File browser buttons and controls:

- ^ — click to go up one level.
- **Home** — click to go to the current users home data directory.
- **CD/DVD t**— click to go to the currently open CD or DVD directory.
- + (or double clicking a directory)— to open that directory and make it the top level currently in the file browser and also the Locator.

File recognized by the locator:

- Double clicking on a file or directory— operate on that file or directory as the Locator does. That is, double clicking on an NMR data file loads it just as double clicking on the same data file in the Locator does.
- Drag a files and directories from file browser — operate on that file or directory as the Locator does when dragging to other windows including the graphics canvas and the study queue.

Review Queue panel:

- **\*.img** directories and **\*.fdf** files — drag to the review viewport or the review queue panel for display.
- Double clicking on an **\*.img** directory — browse the directory.

The top level of the file browser is editable.

1. Click on the top item to select it.
2. Click again to get the editing cursor.
3. After editing, hit the **Return** key to display the new directory.

## E.2 Image Browser

Refer to the *VnmrJ Imaging Users Guide* manual.

## Numerics

- 14-Channel Shim Supply, 121
- 768 AS sample changer accessory, loading software for, 23
- 768 AS sample changer, config entry, 34
- 90-degree pulse length, 89

## A

- absolute-intensity mode, 88
- accounting
  - adding users to groups, 75
  - deleting a user from an accounting group, 76
  - deleting an empty accounting group, 76
  - managing groups and group members, 75
  - report generation, 74
  - selecting a printer, 75
  - updating and saving records, 76
  - viewing user and group lists, 74
- Accounting Procedures, 71
- accounting tool, 69
- acqproc user, 20
- acquisition
  - communication, 29
  - processor interface, 35
  - setting up (setacq command), 29
- Acquisition CPU
  - board, 121
  - initializing NVRAM, 119
  - VxWorks, 119
- ADC, 35
- Add Group window, 71
- Add Printer, 62
- Add User window, 75
- adding
  - users, 40
- adding users to groups
  - accounting, 75
- addprobe, 79
- adept program for spectral editing, 91
- air line traps, 105
- air plugs, 106
- amplifier type, 37, 38
- angled brackets (< or >) notation, 11
- AP interface type, 35
- ASM-100 sample changer, 116
- asphyxiation hazard, 108
- audio filter type, 34
- AUI-to-10baseT transceiver, 16
- authorized operator, 52
- AutoCalibration
  - carbon, 84
  - H and indirect detection, and gradients, 87
  - H, C, indirect detection, and gradients, 86
  - phosphorus, 85
  - proton, 83
  - Z0 and Make LOCK gmap, 87
- AutoCalibration samples, 83
- automatic sample changer, 34, 38
- Automation, 46
- Automation Configuration, 61

- automation queue, 46
- Automation Queue, set up day and night queue times, 61
- AutoTest, loading software for, 23
- axial gradients, 94
- axial shims, 100

## B

- back projection programs, loading, 23
- Background Colors, 46, 66
- backslash notation, 11
- billing
  - calculating, 73
- billing rates
  - designating holidays, 73
  - holiday, 73
  - multiple-rate, 72
  - setting up, 71
  - single-rate, 71
  - weekday daytime, 72
  - weekday night, 72
  - weekend, 72
- BIR-shaped pulse statements, loading, 23
- boiling point of helium and nitrogen, 107
- broad peak base, 99
- broadband, rf, 36
- Butterworth filter, 34

## C

- C13.par file, 90
- calibrate
  - carbon, 84
  - fluorine, 85
  - phosphorus, 85
  - proton, 83
  - proton, ID, and gradients, 87
  - proton-carbon ID and gradients, 86
- Carousel sample changer, config entry, 34, 38
- cdept macro, 91
- CD-ROM drives
  - installing, 14
- Changing
  - User Directories, 59
- Changing User Templates, 58
- changing VnmrJ interface for a user account, 50
- Chemical Shift Imaging, loading, 23
- coarse attenuator, 36
- color LaserJet printer, setting up a, 128
- color printers, 128, 130
- Command window, 46
- CONFIG
  - keyboard input, 33
- CONFIG buttons
  - Exit and Save, 39
  - Help, 39
  - Print, 39
  - Quit, No Save, 39
  - Use Console Data, 39
- CONFIG labels
  - AP interface type, 35
  - audio filter type, 34
  - coarse attenuator, 36

# Index

- configuring channels, 36
- console type, 34
- fifo loop size, 35
- fine attenuator, 37
- frequency overrange, 36
- frequency step size, 36
- gradients, 35
- IF frequency, 35
- latching, 36
- lock frequency, 35, 38
- max decoupler, 38
- max narrowband width, 35
- max spectral width, 35
- maximum DMF, 34
- Number of Receivers, 34
- number of rf channels, 35
- proton frequency, 34, 38
- Pulsed Field Gradient, 38
- rotor synchronization, 35
- sample changer, 34, 38
- sample changer serial port, 34, 38
- shimset, 34, 38
- synthesizer, 36
- system type, 34, 38
- Type of Amplifier, 38
- type of amplifier, 37
- type of rf, 36
- upper limit, 37
- VT controller, 34, 38
- waveform generator, 37

Configuration

- MERCURY Series, 38

configuration tool, 30

Configure, users and operators, 51, 52, 53, 55, 56, 57, 61

Configuring Channel, 36

conpar file, 39

console type, 34

conventions used in manual, 11

Converting user accounts to VnmrJ accounts, 55

Cost Accounting, 46

coupling constant, 89

CPU Initialization

- MERCURY Series, 119

creating

- imaging experiment users, 43

## D

- d1 parameter, 88
- DAC values, 94
- data acquisition set up, 29
- data station, 34, 38
  - MERCURY, 38
- DataBase error message, 41
- database owner, 40
- Day-Q, 61
- dbsetup command, 41
- decoupler
  - 90-degree pulse width tests, 90
  - field strength, 89, 90
  - field strength check, 105
  - field strength tests, 90
  - power level, 89

- pulse width calibration, 92, 93
- pulses, 89
  - rf field homogeneity, 93
  - X pulse widths, 93
- decoupler modulation, frequency, 34
- delete a user from an accounting group, 76
- delete an empty accounting group, 76
- Delete Operator tab, 54
- Delete operators, 52, 53, 57
- Delete Printer, 65
- Deleting
  - user accounts, 54
- Deleting an operator from a single user account, 54
- Deleting operators from a user account, 53
- density of helium and nitrogen, 107
- dept macro, 91
- DeskJet 5550, 126
- detune the probe, 89
- device types, 63
- devicenames file, 128
- dewar servicing, 111
- dhp/dlp parameter, 89
- Dicom Storage, 46, 66
- diffusion experiments, loading software for, 23
- dioxane sample, 90
- direct synthesis rf, 36
- dmf parameter, 89
- dmf parameter, 34
- DOSY experiment, loading, 23
- dpwr parameter, 89
- dump command (UNIX), 105

## E

- Edit operators, 52, 53, 57
- elliptical filter, 34
- E-mail, 52
- Email, 52
- error messages
  - Linux OS, 27
  - Solaris OS, 26
- Ethernet
  - boards, 14
    - built-in, 14
    - first, 14
    - network, 14
    - ports, 14
    - second, 14
- Ethernet boards
  - 10baseT, 14
  - autosensing 10/100baseT, 14, 15
- Exit, 46
- Exit and Save config button, 39

## F

- face mask for handling LHe, 108
- FDM, loading software for, 23
- fiddle reference deconvolution, loading, 23
- fifo loop size, 35
- File System, 46
- fine attenuator, 37
- fixed frequency rf, 36
- floppy disk drive, installation, 14

flow rates of nitrogen and helium, 105  
 flowmeter valve, 112  
 flutter tube, 109  
 fourth rf channel, 33  
 frequency overrange, 36  
 function menu bar, VnmrJ administrator, 46

## G

gamah2.par file, 89  
 GEMINI 2000 spectrometers setacq command, 29  
 $\gamma\text{H}_2$  (decoupler field strength), 89  
 global parameter file, 39  
 gloves for handling LHe, 108  
 GNU C compiler, loading, 23  
 gradient shimming, loading software for, 23  
 gradients configuration, 35  
 gripper drops sample, 117

## H

h2cal command, 90  
 hcdect macro, 91  
 heat of vaporization, 107  
 helium flowmeter, 105  
 helium gas storage cylinder, 111  
 help, 46  
 Help config button, 39  
 Hewlett-Packard printers, 123, 126, 127, 128, 129, 130  
 holiday  
   designating, 73  
 Home Directory, 49, 50, 52  
 Horizontal NMR Imaging systems, 43  
   upper limit, 37  
 host computer, unpacking the hardware, 13

## I

ice blockage, 114  
 ice plugs, 109  
 IF frequency, 35  
 imaging  
   experiment user, creating an, 43  
   loading software for, 23  
   pulse sequences, loading, 23  
   software, verifying installation of, 43  
   systems configuration, 43  
 indirect detection calibrations  
   H and gradients, 87  
   H, C, and gradients, 86  
 indirect detection experiments, 93  
 Input board, defining max spectral width, 35  
 installing patches, 20  
 Interface Type, 49, 50, 52  
 Investigator List, 46  
 ionic samples, 89

## K

Kermit (serial port) communication software,  
 loading, 23

## L

LaserJet 2300, 127  
 LaserJet series printers  
   prints strange characters, 131  
 latching, 36  
 latent heat of vaporization, 106  
 LC-NMR experiments, loading software for, 23  
 LC-NMRr, config entry, 34  
 Lexmark Optra Color 45 Inkjet Printer, 124  
 Limnet software, loading, 23  
 linear shim Z1, 95  
 lineshape check, 105  
 Linux, 19  
 liquid helium  
   dewar service, 111  
   handling, 106  
   handling safety, 108  
   level in dewar, 105  
   measuring, 109  
   safety precautions, 108  
   storage containers, 108  
   transferring, 109  
 loading VNMR and VnmrJ, 23  
 local maxima, 102  
 locator  
   setting viewing access privileges, 135  
 Locator shows Error, 41  
 lock frequency, 35  
   MERCURY, 38  
 log book, 91  
 low-order shims, 100

## M

MAGICAL macros for spectral editing, 91  
 Magnet and Sample Regulation board, 121  
 magnet quench cause, 110  
 managing groups and group members  
   accounting, 75  
 manual notational conventions, 11  
 manuals  
   online, installation, 24  
 Max Length, 61  
 maximum decoupler power  
   MERCURY, 38  
 maximum DMF, 34  
 maximum narrowband width, 35  
 maximum spectral width, 35  
 measuring liquid helium in a container, 109  
 melting point of helium and nitrogen, 107  
 menthol sample, 90  
 MERCURY spectrometers  
   10baseT cable, 16  
   10baseT reversible cable, 16  
 MERCURYplus/-Vx  
   Host Connection, 16  
 MERCURYplus/-Vx console connection, 16  
 Modify Operators, 52, 57  
 modulation frequency parameter, 89  
 molecular weight of helium and nitrogen, 107  
 monthly maintenance, 105  
 movesw macro, 88  
 movetof macro, 88

## Index

MSR board, 121  
mult parameter, 91  
Multiple New User Accounts, 49

## N

New User Account  
  setting up, 48  
New User Accounts  
  setting up multiple accounts, 49  
Night-Q, 61  
nitrogen flowmeter, 105  
NMS sample changer, config entry, 34, 38  
non-spin shims, 99  
notational conventions, 11  
notebooks for system, 106  
number of receivers, 34  
number of rf channels, 35  
NVRAM initialization, 119

## O

odd-order shims, 97  
off-resonance decoupling, 89  
offset synthesizer, 36  
operating system  
  patches, 20  
Operating Systems, 19  
Operations Log notebook, 106  
Operator  
  deleting a user account, 54  
  resetting password, 53  
  setting preferences, 51  
Operators, 46  
  adding to a user account, 51  
  deleting from user account, 53  
optional internal devices, 14  
organic solvents, 89

## P

Panel Level, 52  
panel level defaults, 57  
panel levels, 57  
parameters  
  setting, 30  
Password, 53  
password options and descriptions, 23  
patches, 20  
  installing, 20  
peak asymmetry, 96  
peak broad base, 99  
peak broadening, 97  
PFG experiments, loading parameters for, 23  
plotters  
  troubleshooting, 123  
plotting  
  device types, 63  
polar solvents, 89  
polarization transfer, 90  
pp parameter, 90, 91, 92  
ppcal macro, 92  
PPCAL pulse sequence, 92

precooling the transfer tube, 110, 111, 112  
Preferences  
  setting operator, 51  
pressure regulator, 111  
pressure-relief valves, 108  
preventative maintenance, 105  
Print config button, 39  
Printer name, 62  
Printer type, 62  
Printers, 46  
printers  
  adddevices command, 132, 133  
  color LaserJet, setting up a, 128  
  installation on Sun Ultra 5, 131  
  LaserJet prints strange character, 131  
  LaserJet series troubleshooting, 131  
  lp command, 132, 133  
  paper format, 132, 133  
  parallel port-Sun, 132  
  plot quality, 132, 133  
  reboot after software upgrade, 132, 133  
  troubleshooting, 123  
Printers and Plotters  
  removing, 65  
  setting up, 62  
  viewing installed, 65  
printing  
  device types, 63  
Probe calibration  
  carbon  
    , 84  
  fluorine, 85  
  phosphorus, 85  
  proton, 83  
  Proton, Carbon, Gradients, using autoest  
    sample., 87  
  Proton, Carbon, Gradients, using C13 enriched  
    CH3I., 86  
  setup, 79  
  Z0 and Make LOCK gmap, 87  
probe tuning, 80  
Procedures Log notebook, 106  
proton calibration, 83  
proton decoupler pulse calibration using PPCAL, 92  
proton decoupler pulse width, 92  
proton frequency, 34  
  MERCURY, 38  
PTS frequency synthesizer, 36  
pulse width calibration, 88  
pulsed field gradient (PFG), setting, 38  
pw90 value, 89  
pwx1 parameter, 93  
pwxcal macro, 93  
PWXCAL pulse sequence, 93

## Q

quench, magnet, 110, 111  
Quit, No Save config button, 39

## R

radial shims, 102

receivers, multiple, 34  
 Redhat Linux, 19  
 relaxation time, 88  
 Removing  
   Printers and Plotters, 65  
 Reset password, 51, 52, 53, 57  
 residual couplings in dioxane, 90  
 Restoring  
   user accounts, 55  
 Return key, 11  
 rf channels, 33  
 rf field homogeneity of decoupler, 93  
 rotor synchronization, 35  
 router, 16  
 routine shims, 100  
 RRI serial cable, 121

**S**

safety precautions, 108  
 safety vent valve, 110  
 sample changer, 116  
   serial port, 34, 38  
   type, 34, 38  
   VAST, 34, 38  
 sample scoring problems, 116  
 second channel, 35  
 second Ethernet board, 14  
 second SCSI board, 14  
 selecting multiple items or accounts, 46  
 serial ports, used for sample changer, 34, 38  
 setacq  
   MERCURYSeries, 29  
 setacq command, 29  
 setlockfreq command, 40  
 setting  
   parameters, 30  
 Setting up  
   Printers and Plotter, 62  
 shim gradient supply data connection, 121  
 shimming procedures, 94  
 shims  
   asymmetry, 96  
   broadening of the peak, 97  
   complex lineshapes, 98  
   effects on symmetry of the resonance, 94  
   even-order, 96  
   first-order spinning sidebands, 99  
   illustration of shim interactions, 94  
   linear, 95  
   non-spin, 99  
   odd-order, 97  
   removing spinning sidebands, 101  
   second-order spinning sidebands, 99  
   setting high-order axial shims, 101  
   setting high-order radial shims, 102  
   setting low-order or routine, 100  
   shapes of the axial gradients, 94  
   theoretically predicted changes in lineshape, 94  
   typical interactions for axial shims, 100  
   what are they, 94  
   when more than one are misadjusted, 98  
 shimset, 34, 38  
 shipping damage, 13

Show all VJ Users, 48, 49, 50, 51, 54, 59  
 signal-to-noise check, 105  
 SIS imaging systems, configuration, 43  
 skin damage from helium and nitrogen, 108  
 SMS sample changer, 116  
 SMS with 50-sample/100-sample tray, 34, 38  
 software  
   installation, 20  
   loading, 23  
 Solaris 7, 19  
 Solaris 8, 19  
 Solaris 9, 19  
 Solaris Printers, 66  
 Solaris Printers Configuration window, 66  
 spectral editing, 91  
 spin test, 116  
 spinner does not rotate, 117  
 spinning instabilities, 116  
 spinning sidebands, 99  
 spinning sidebands, removing, 101  
 STARS software, loading, 23  
 steady-state, 88  
 step size in synthesizer, 36  
 stinger, 111, 115  
 storage dewar, 110  
 Sun computer  
   checking for shipping damage, 13  
   optional internal devices, 14  
   unpacking, 13  
 swept fm decoupling, 89  
 synthesizer, 36  
 system  
   configuration, 30  
   type, 34, 38  
 System Log notebook, 106  
 system type  
   MERCURY, 38

**T**

$T_1$  time, 88  
 tape backups, 105  
 tar command (UNIX), 105  
 thermal acoustical liquid level indicator, 109  
 third rf channel, 33, 35  
 Times, 61  
 transceiver installation  
   MERCURY spectrometers, 16  
   UNITYINOVA, 16  
 transfer line, 109  
 transfer tube, 108, 110, 111  
 transferring LHe from a storage container, 109  
 triple-resonance experiments, 93  
 troubleshooting  
   sample changer, 116  
 tuning probes, 80  
 type of amplifier, 37  
 type of rf, 36

**U**

Ultra•nmr Shims, 94  
 Unaccounted Users list, 75  
 UNITYINOVA spectrometers



## Index

- 10baseT cable, 16
- 10baseT reversal cable, 16
- setacq command, 29
- shim gradient supply data connection, 121
- Unix File System
  - viewing, 60
- update and save records
  - accounting, 76
- Updating user accounts, 56
- upfield tail on the peak, 96
- upper limit of coarse attenuator, 37
- Use Console Data config button, 39
- User Account
  - adding operators, 51
  - Changing User Directories, 59
  - deleting, 54
  - deleting one or more operators, 54
  - deleting operators, 53
  - Interfaces, 47
  - modifying operators, 52
  - restoring, 55
  - setting or changing the VnmrJ interface, 50
  - setting panel levels, 57
- User Account Defaults, setting, 58
- user accounting log, 69
- User Accounts
  - Changing User Templates, 58
  - converting vnmr accounts to VnmrJ accounts, 55
  - updating, 56
- user accounts, 48
- User Directories
  - setting and changing, 59
- User Login, 49
- User Name, 49
- User Profile Panel, 49, 50, 52
- User Templates
  - changing and setting, 58
- User Templates, Directories, and Defaults, setting, 58
- Userlib, loading, 23
- Users, 46
- users
  - adding, 40
  - imaging experiment, creating, 43
- Users..., 46

## V

- vapor density of helium, 107
- vaporization property of helium, 107
- Varian NMR User Pages, 20
- VAST sample changer, config entry, 34, 38
- VAST sample changing accessory, loading software for, 23
- venting helium vapor, 107
- viewing installed printers and plotters, 65
- viewing user and group lists
  - accounting, 74
- VNMR
  - accounting window, 70
- VNMR Printers Configuration window, 65
- vnmr\_accounting command, 69
- VnmrJ

- installing online manuals, 24
- options, 23
- VnmrJ Administrator
  - operator account set up, 48
- VnmrJ administrator, 45
- VnmrJ interface
  - Experimental, 47
  - Imaging, 47
  - setting or changing user account, 50
  - Walkup, 47
- VnmrJ Operator, 49, 50, 52
- VT controller type, 34
  - MERCURY, 38
- VxWorks
  - command mode, 119
  - prompt, 119

## W

- WALTZ-16 decoupling, 89
- waveform generator, 37
- weekly maintenance, 105
- weight of nitrogen-shielded container, 107
- workstation and console connections, 15

## X

- X decoupler pulse calibration using PSXCAL, 93
- X2-Y2 non-spin shim, 99
- XY non-spin shim, 99

## Y

- Y non-spin shim, 99

## Z

- Z0 and Make LOCK gmap calibration, 87
- Z1 linear shim, 95
- Z2 even-order shim, 96
- Z3 odd-order shim, 97
- Z4 even-order shim, 96
- Z5 odd-order shim, 97
- ZX non-spin shim, 99
- ZY non-spin shim, 99